

MANUALE D'USO STRIP LED DOT FREE 0 TYPE

STRIP LED DOT FREE MANUAL USER

0 Type

EMISSIONE LATERALE

SIDE EMITTING

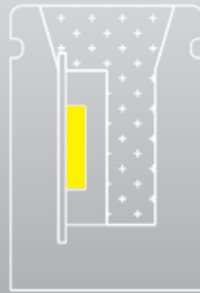

Caratteristiche del prodotto / Product Features:

- Emissione laterale
- Profilo estremamente piatto, perfetto per le installazioni ad incasso
- IP65/67 Impermeabile
- Silicone a doppio colore
- Zona d'aria incavata per una buona dissipazione del calore
- *Side-emitting, bendable laterally*
- *Extremely flat profile, perfect for recessed installation.*
- *IP65/67 Waterproof*
- *Dual color of silicone*
- *Hollow air layer for good heat dissipation*

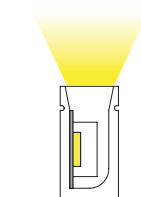

Emissione laterale
Side-emitting

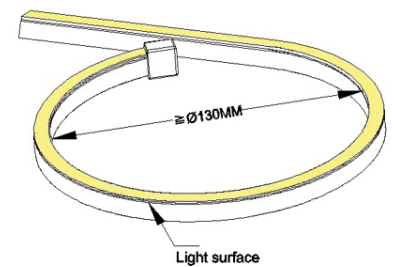

Light surface

Applicazioni / Applications:



EMISSIONE LATERALE, CURVABILE LATERALMENTE

SIDE-EMITTING, BENDABLE LATERALLY

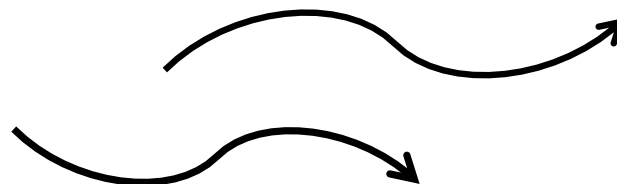
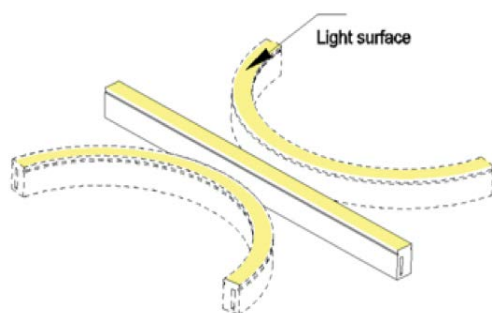

AVANTI / INDIETRO
FORWARD / BACKWARD



- Adatta per progetti artistici e decorazioni.



- Convenient for artistic design and decoration.

DISPONIBILE IN QUATTRO DIMENSIONI

FOUR SIZES OPTIONAL

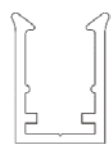
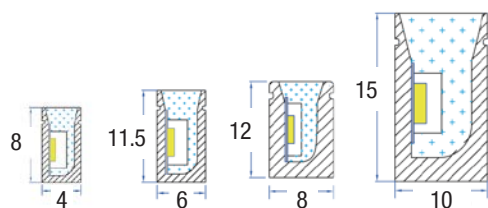

Clip di fissaggio
Mounting clip

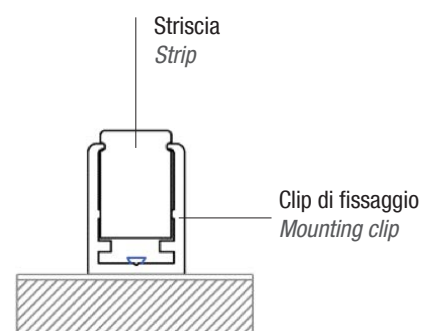

- Opzioni per gestire le diverse modalità di installazione.



- Options for dealing with different installation circumstances.

USCITA CAVO: PARTE FINALE/LATERALE/INFERIORE

CABLE FROM : END/SIDE/BOTTOM

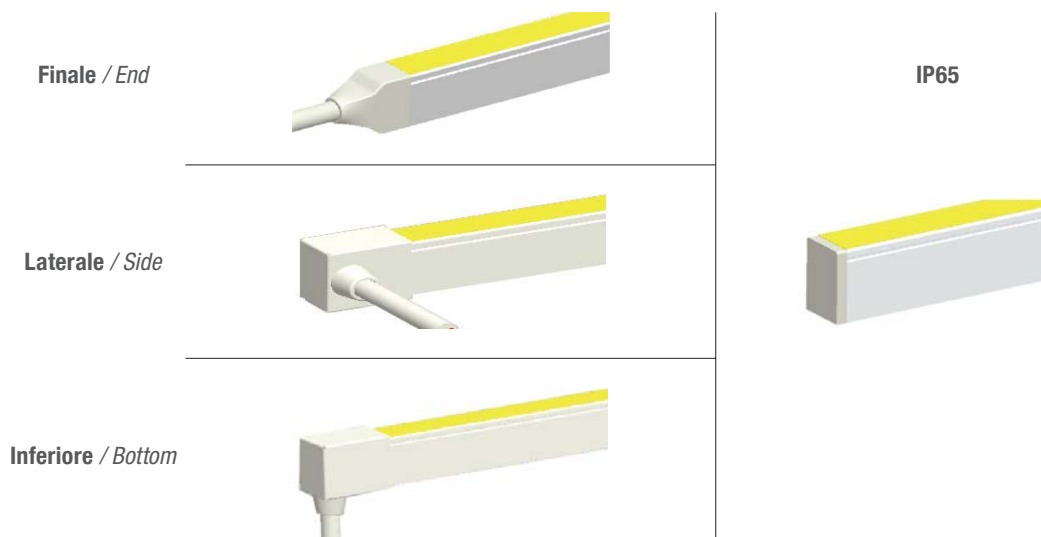

ACCESSORI

ACCESSORIES



Cavo e tappo anteriore (IP67)
Cable & Front Cap (IP67)



Tappo di chiusura (IP67)
End Cap (IP67)



Clip di fissaggio
Mounting Clip



Set completo di accessori per l'installazione. (tappo anteriore-posteriore, clip di fissaggio e cavo) Taglio e collegamento semplificati.



Full set of installation accessories. (front-end cap, mounting clip and cable) Easy cutting and connection.

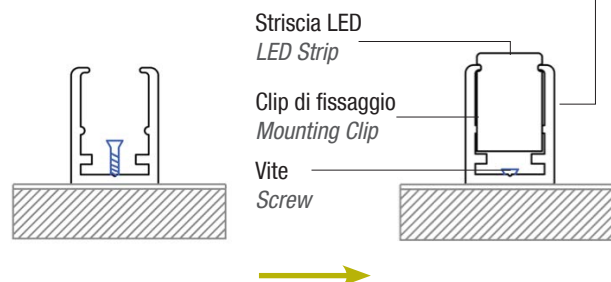

UNITÀ DI TAGLIO

CUTTING UNIT

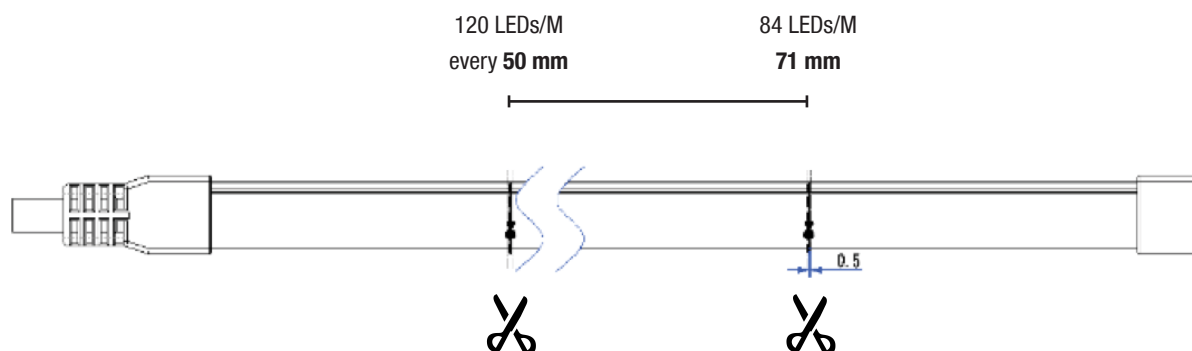

È possibile tagliarla nel punto di taglio indicato sul lato della striscia.



Can be cut along the cutting mark on the side of strip.

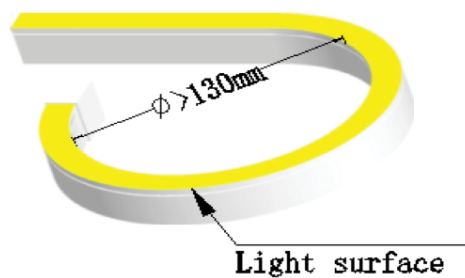

Superiore a 130 mm
Not less than 130 mm



La striscia può essere curvata sui due lati ma il diametro minimo di curvatura deve essere superiore a 130 mm.



The strip can be bent along two lateral side but not less than 130mm of bending diameter.

PROFILO IN ALLUMINIO

ALUMINUM PROFILE

Oltre agli accessori di installazione generali, sono disponibili quattro profili di alluminio progettati esclusivamente come accessori opzionali.

In addition to general installation accessories, there are four exclusively designed installation Aluminum profiles as optional accessories.

4 mm

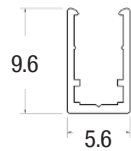

6 mm

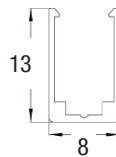

8 mm

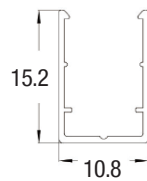

10 mm

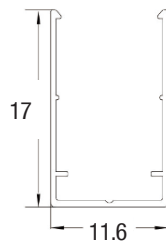

PROCESSO DI TAGLIO E COLLEGAMENTO

EASY SELF-CUTTING AND CONNECTION PROCESS



Fase 1. Individuare il punto di taglio riportato sulla striscia.
Step 1. Find the cutting line mark.



Fase 2. Separare la striscia tagliandola nel punto di taglio indicato.
Step 2. Split the strip along the cutting mark by knife.

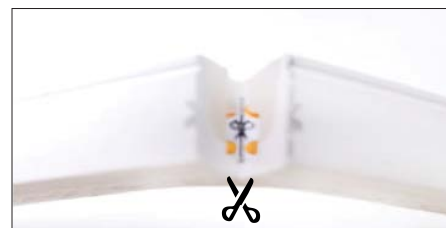

Fase 3. Tagliare, servendosi di forbici, il PCB all'interno della striscia, lungo la linea di tratteggio indicata.
Step 3. Cut the PCB along the cutting mark inside the strip by scissors.

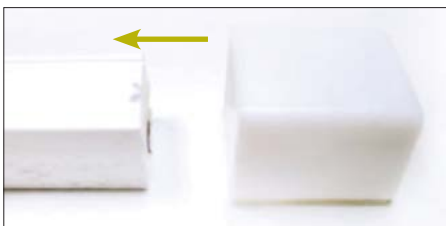

Fase 4. Fissare l'estremità finale della striscia con il tappo di chiusura.
Step 4. Fix the strip end into end cap.

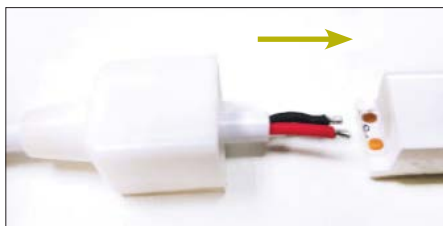

Fase 5. Saldare il cavo sul PCB e unire la parte anteriore della striscia con il tappo anteriore.
Step 5. Solder the cable onto PCB and connect the strip front and front cap.



Fase 6. Utilizzare del silicone per bloccare il tappo di chiusura e quello anteriore.
Step 6. Use silicone glue to adhere end cap and front cap.

ACCESSORI STRIP LED DOT FREE

STRIP LED DOT FREE ACCESSORIES

"0" Type



Dot Free Type "0" 8mm Extension Connector
3ILDFOEXC8



Dot Free Type "0" 8mm Strip To Strip Connector
WW-3ILDFOSTSC8



Dot Free Type "0" 8mm Strip To Wire Connector
3ILDFOSTWC8



Dot Free Type "0" 8mm End Cap Connector
3ILDFOECC8

Profili - Profile



Moldable Profile

4mm "0" Type 3ILLG0510-500
6mm "0" Type 3ILLG0712-500
8mm "0" Type 3ILLG0911-500
Confezione 5m / pack 5m



Aluminum Profile

4mm "0" Type 3ILAP1006-100 _ 1000mm Lenght
6mm "0" Type 3ILAP0813N-100 _ 1000mm Lenght
8mm "0" Type 3ILAP1510-100 _ 1000mm Lenght
10mm "0" Type 3ILAP1712-100 _ 1000mm Lenght



PC Mounting Clip

4mm "0" Type 3ILPC1006-0025 _ 25mm Lenght
6mm "0" Type 3ILPC0813-0025 _ 25mm Lenght
8mm "0" Type 3ILPC1611-0025 _ 25mm Lenght
10mm "0" Type 3ILPC1713-0025 _ 25mm Lenght