

Warm Dimming LED Spot Modules

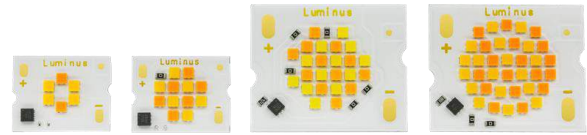

Features:

- High lumen density for directional lighting
- Dim-to-warm with IC chip and LM-80 tested MP-1616 XNOVA Cube™ LEDs on metal PC board
- Enables system beam angles from 10 to 40 degrees
- Simplifies lamp and luminaire design
- Compatible with most single channel drivers and dimmer switches
- Up to 97CRI (typical) at 3000K dimming down to 1800K for residential and hospitality lighting
- 92CRI (typical) 4000K to 2700K warm dimming for commercial lighting
- Two dimming curve options: “halogen-like” -DW01 and “linear-style” -DW02
- Consistent white light <3 SDCM
- Specified “hot” performance and 100% factory tested at Tj=85°C

Applications:

- Hospitality / hotel / restaurant lighting
- Residential lighting
- Retail shop lighting
- Public, commercial buildings
- Ceiling and wall mount lights

Products Families:

- CDM-6-XXXX-YY-18-DW0x: Typical 5.5W
- CDM-9-XXXX-YY-36-DW0x: Typical 11W
- CDM-14-XXXX-YY-36-DW0x: Typical 21.5W
- CDM-18-XXXX-YY-36-DW0x: Typical 32.5W
 - XXXX: CCT range (“3018” = 3000K to 1800K)
 - YY: CRI (“90” = either 92 or 95 min, refer to page 3)
 - “18” or “36” = nominal voltage
 - DW01 = standard configuration with “halogen-like” dimming curve
 - DW02= standard configuration with “linear-style” dimming curve

Technical Data

Electrical data and maximum ratings (@T_j =85°C):

Part Number	Nominal Input Power	Maximum Input Power	Nominal Current	Absolute Maximum Current	Typical Voltage@ Nominal Current	Maximum Voltage @ Nominal Current
CDM-6-3018-90-18-DW0x	5.5W	8.5W	300mA	440mA	17.8V	19V
CDM-6-4027-90-18-DW0x	5.5W	8.5W	300mA	440mA	17.8V	19V
CDM-9-3018-90-36-DW0x	11W	14.5W	300mA	440mA	35.5V	38V
CDM-9-4027-90-36-DW0x	11W	14.5W	300mA	440mA	35.5V	38V
CDM-14-3018-90-36-DW0x	21.5W	32.5W	600mA	800mA	35.5V	38V
CDM-14-4027-90-36-DW0x	21.5W	32.5W	600mA	800mA	35.5V	38V
CDM-18-3018-90-36-DW0x	32.5W	40W	900mA	1080mA	35.5V	38V
CDM-18-4027-90-36-DW0x	32.5W	40W	900mA	1080mA	35.5V	38V

Absolute maximum ratings & optical/electrical characteristics:

Parameter	Symbol	Minimum	Typical	Maximum	Unit
Operating case temperature	T _c			105	°C
Junction temperature	T _j			125	°C
Viewing angle	2(Θ1/2)		130		degrees
Reverse voltage	V _r			5	volts
Ambient operating temperature	T _{opr}	-40		+85	°C
Storage temperature	T _{sto}	-40		+85	°C
Electrostatic Discharge	ESD			4000V	HBM

Photometric data (@nominal forward current & T_j =85°C):

Halogen-like (-DW01) Series

Part number	Nominal Current	Minimum Flux (lumens)	Typical Luminous Efficacy	Typical Flux (lumens)	Minimum CRI (Ra)
CDM-6-3018-90-18-DW01	300mA	465	95 lm/W	510	90
CDM-6-4027-90-18-DW01	300mA	500	103 lm/W	550	90
CDM-9-3018-90-36-DW01	300mA	900	95 lm/W	1000	95
CDM-9-4027-90-36-DW01	300mA	1000	103 lm/W	1120	90
CDM-14-3018-90-36-DW01	600mA	1760	95 lm/W	1975	95
CDM-14-4027-90-36-DW01	600mA	2000	103 lm/W	2240	90
CDM-18-3018-90-36-DW01	900mA	2730	95 lm/W	3000	95
CDM-18-4027-90-36-DW01	900mA	3030	103 lm/W	3360	90

Linear-style (-DW02) Series

Part number	Nominal Current	Minimum Flux	Typical Luminous Efficacy	Typical Flux	Minimum CRI (Ra)
CDM-6-3018-90-18-DW02	300mA	440	90 lm/W	485	90
CDM-6-4027-90-18-DW02	300mA	470	100 lm/W	525	90
CDM-9-3018-90-36-DW02	300mA	860	90 lm/W	960	95
CDM-9-4027-90-36-DW02	300mA	980	100 lm/W	1075	90
CDM-14-3018-90-36-DW02	600mA	1720	90 lm/W	1920	95
CDM-14-4027-90-36-DW02	600mA	1980	100 lm/W	2140	90
CDM-18-3018-90-36-DW02	900mA	2600	90 lm/W	2900	95
CDM-18-4027-90-36-DW02	900mA	2900	100 lm/W	3210	90

Mechanical, Thermal, Optical and Electrical Characteristics:

Product Description	Min. CRI (Ra)	CCT at over 90% nominal current	CCT at below 10% nominal current	Light Emitting Surface Diameter	Board Size	Typical Thermal Resistance (Rthj-c)
CDM-6-3018-90-18-DW0x	90	3000K	1800K	6.5mm	12x15mm	2.65 K/W
CDM-6-4027-90-18-DW0x	90	4000K	2700K	6.5mm	12X15mm	2.65 K/W
CDM-9-3018-90-36-DW0x	95	3000K	1800K	9.5mm	12x15mm	1.8 K/W
CDM-9-4027-90-36-DW0x	90	4000K	2700K	9.5mm	12x15mm	1.8 K/W
CDM-14-3018-90-36-DW0x	95	3000K	1800K	14.5mm	20x24mm	0.67 K/W
CDM-14-4027-90-36-DW0x	90	4000K	2700K	14.5mm	20x24mm	0.67 K/W
CDM-18-3018-90-36-DW0x	95	3000K	1800K	16.8mm	20x24mm	0.52 K/W
CDM-18-4027-90-36-DW0x	90	4000K	2700K	16.8mm	20x24mm	0.52 K/W

CCT Change Dimming Curves:

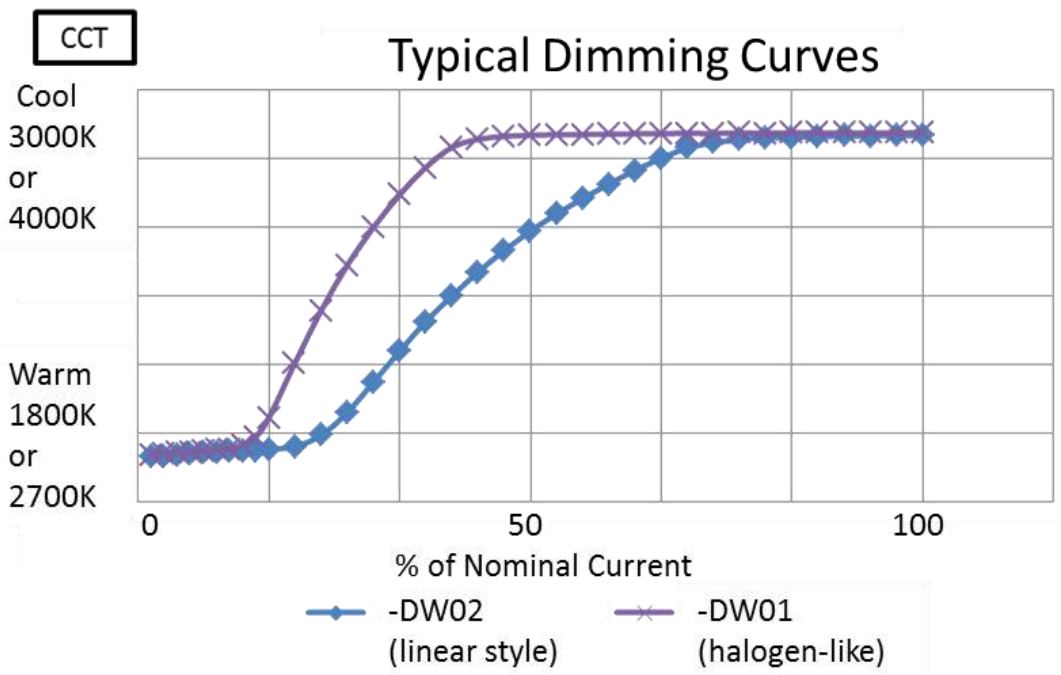

“-DW01” Product Family & Nominal CCTs	Center Point		3-Step		
	CIE _x	CIE _y	θ (°)	a	b
CDM-3018 @ 1800K	0.5656	0.4136	46.510	0.00989	0.00476
CDM-4027 @ 2700K	0.4700	0.4120	54.394	0.00964	0.00421
CDM-3018 @ 3000K	0.4312	0.3990	56.936	0.00959	0.00401
CDM-4027 @ 4000K	0.3799	0.3781	60.532	0.00974	0.00376

“-DW02” Product Family & Nominal CCTs	Center Point		3-Step		
	CIE _x	CIE _y	θ (°)	a	b
CDM-3018 @ 1800K	0.5656	0.4136	46.510	0.00989	0.00476
CDM-4027 @ 2700K	0.4700	0.4120	54.394	0.00964	0.00421
CDM-3018 @ 3000K	0.4348	0.4005	56.711	0.00959	0.00402
CDM-4027 @ 4000K	0.3830	0.3794	60.296	0.00972	0.00378

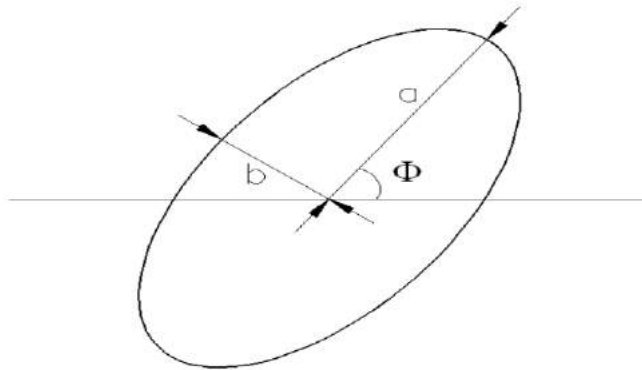

Note: tolerance of chromaticity measurements (x, y) is +/- .005

CDM-4027 and 3018 "-DW01" Chromaticity Bin Structures

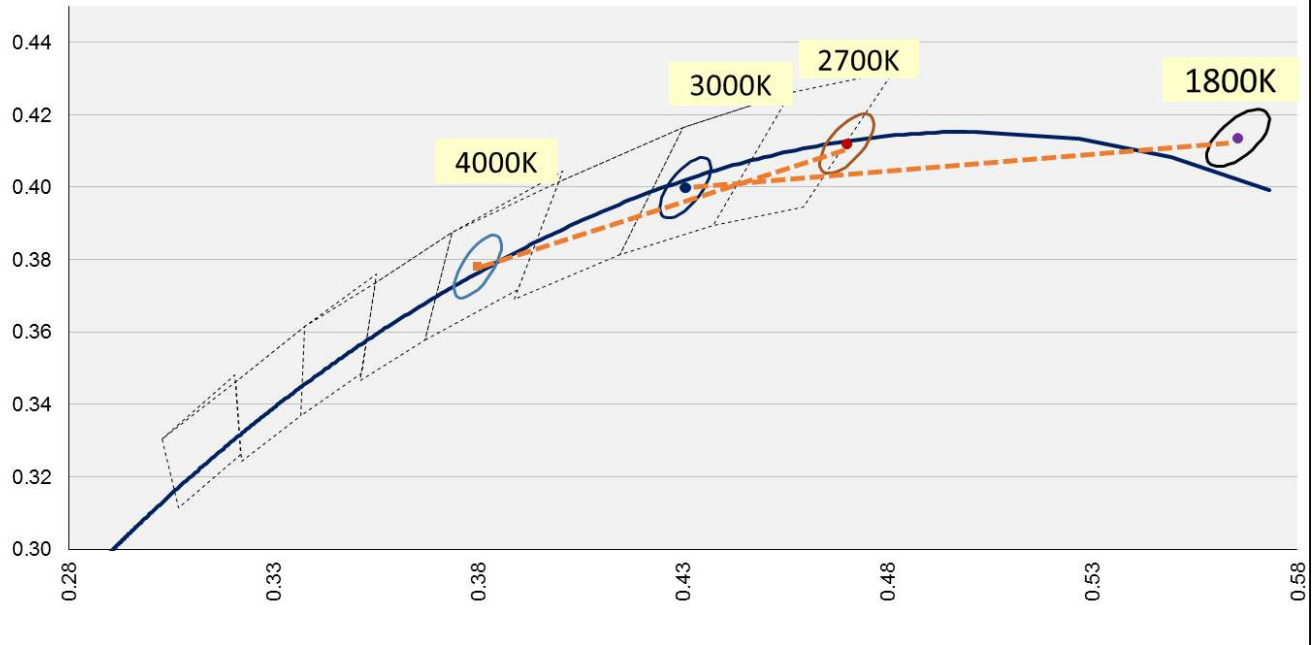

CDM-4027 and 3018 "-DW02" Chromaticity Bin Structures

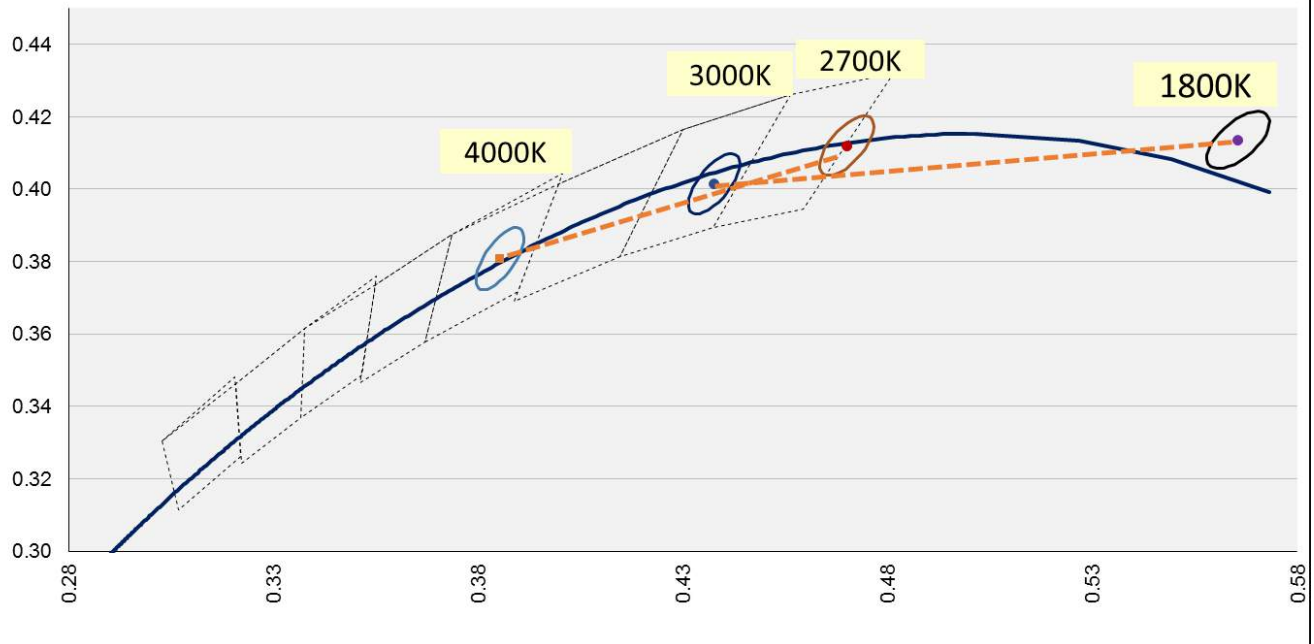

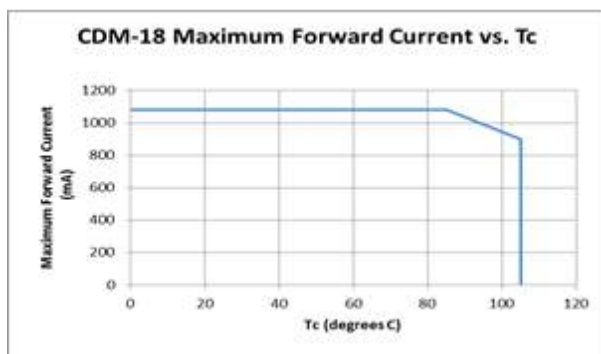
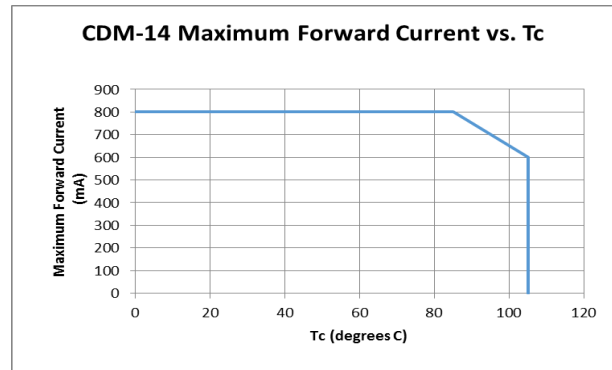
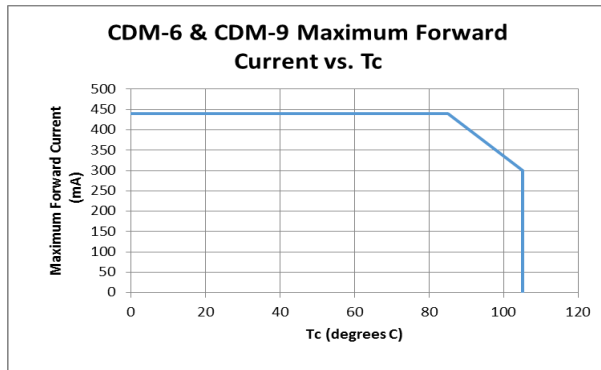
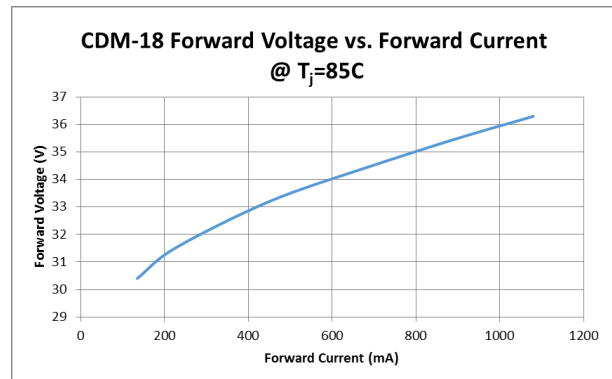
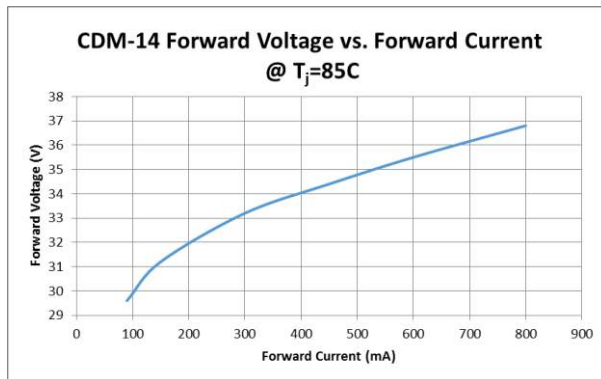
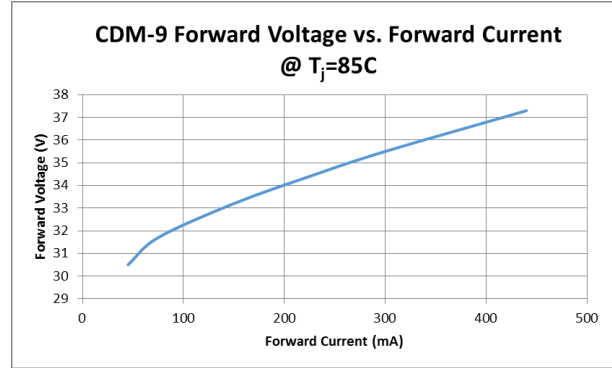
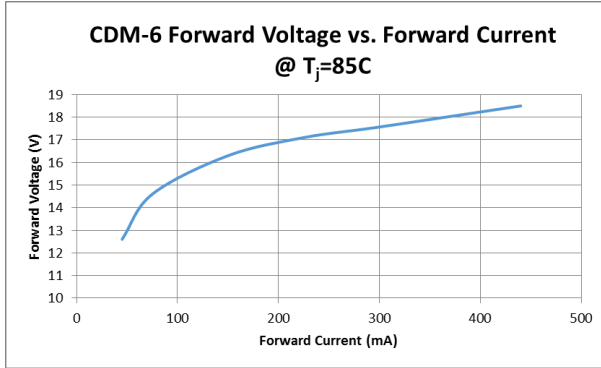

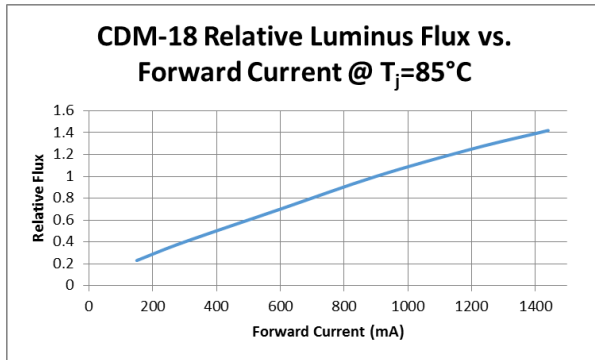
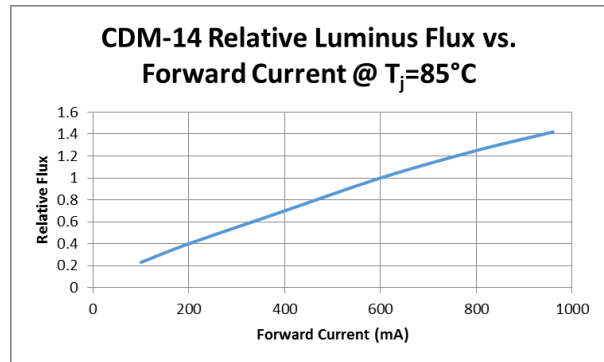
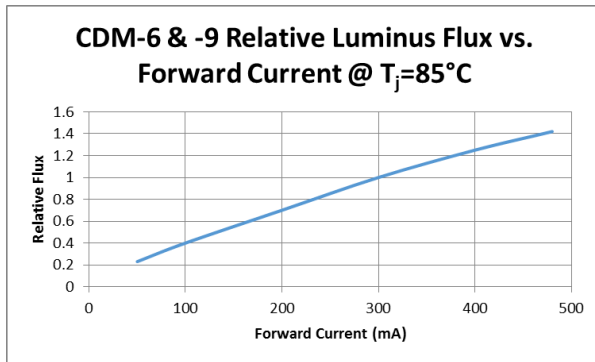
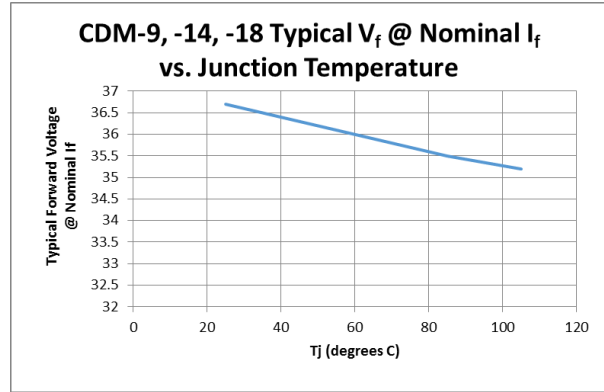
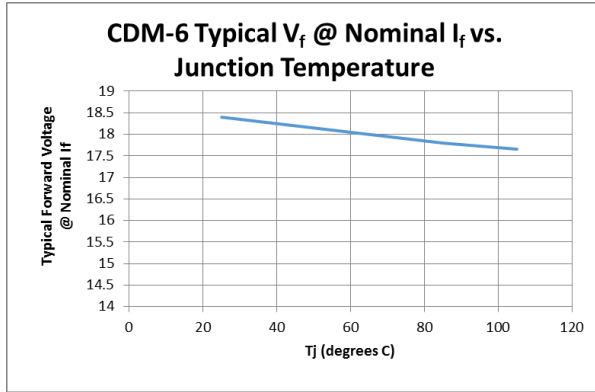

CDM-6 Series Package Dimensions:

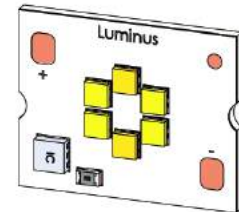
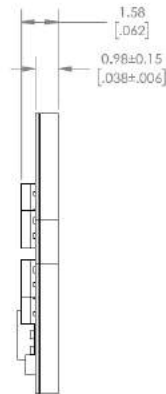
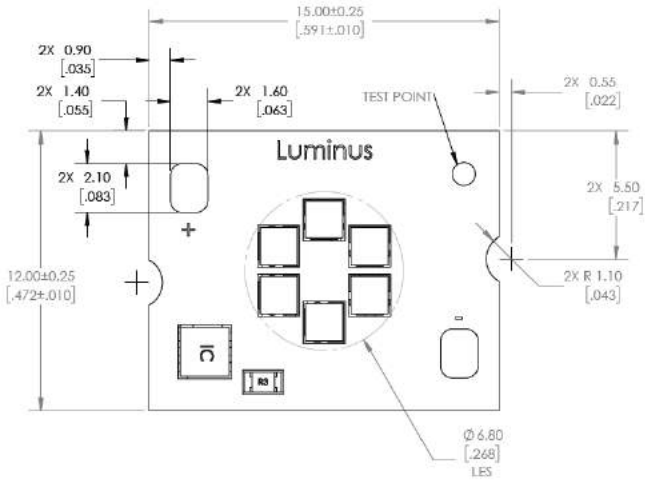

CDM-9 Series Package Dimensions:

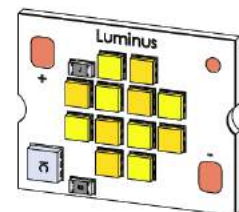
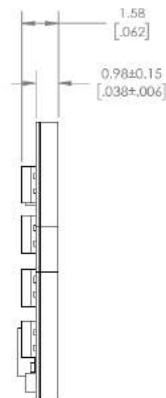
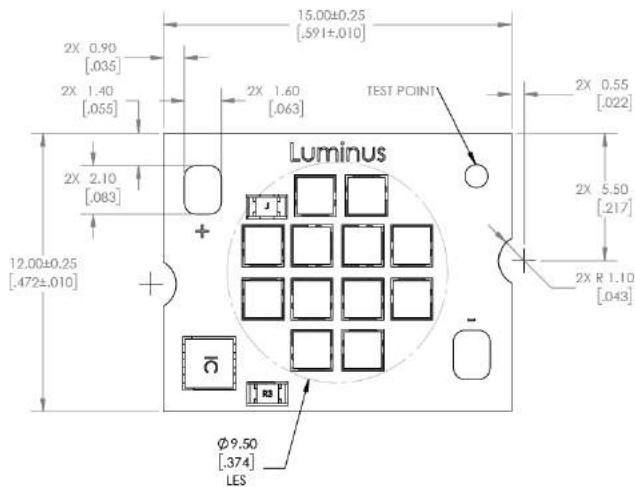

CDM-14 Series Package Dimensions:

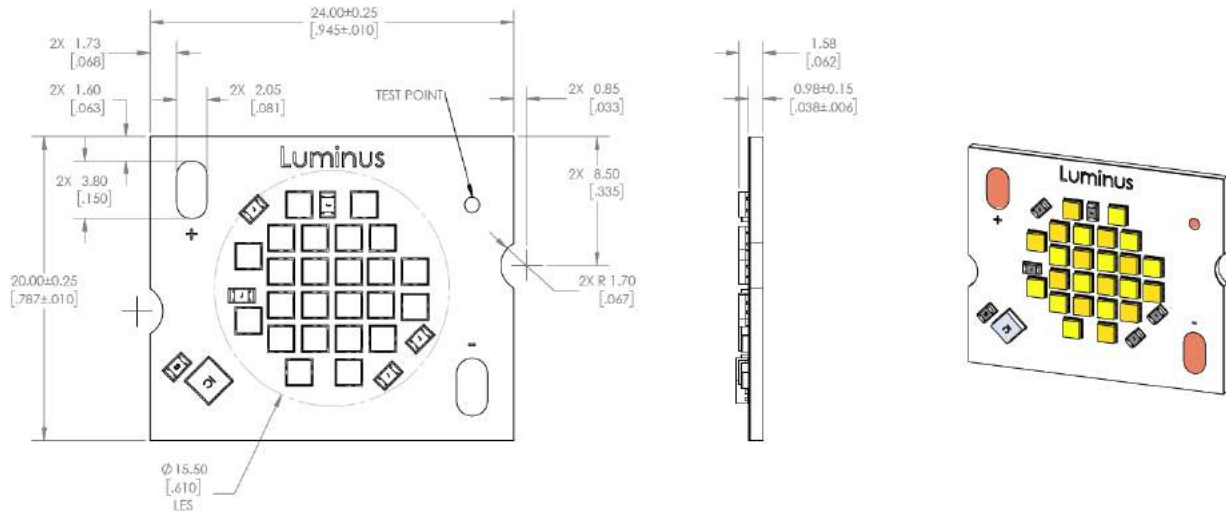

CDM-18 Series Package Dimensions:

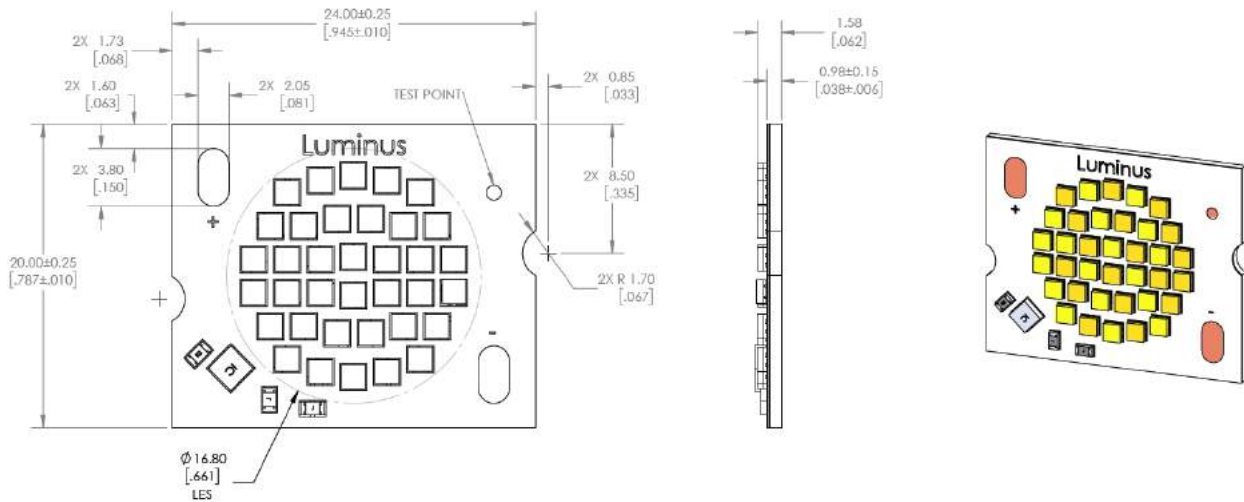

Shipping Container (CDM-6 and CDM-9)

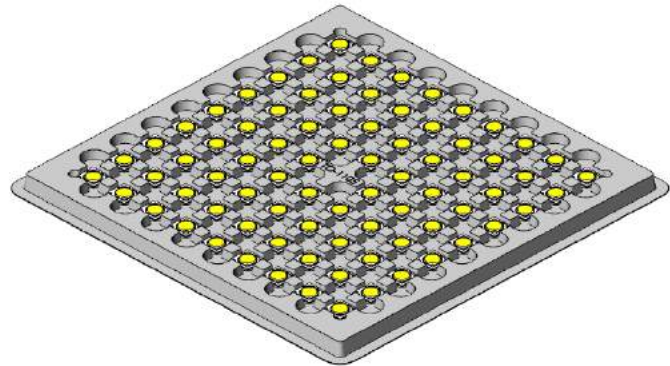
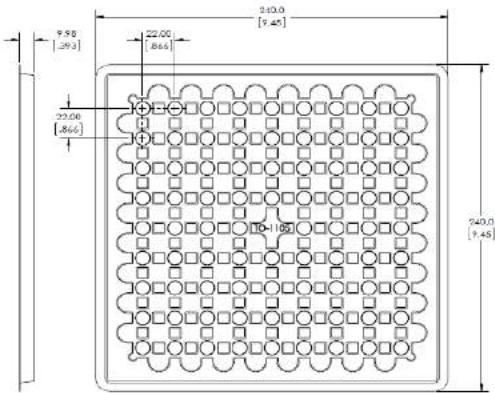

Shipping Container (CDM-14 and CDM-18):
Similar to above but 30 pcs per tray and 150 pcs per box

Luminus Label Model:

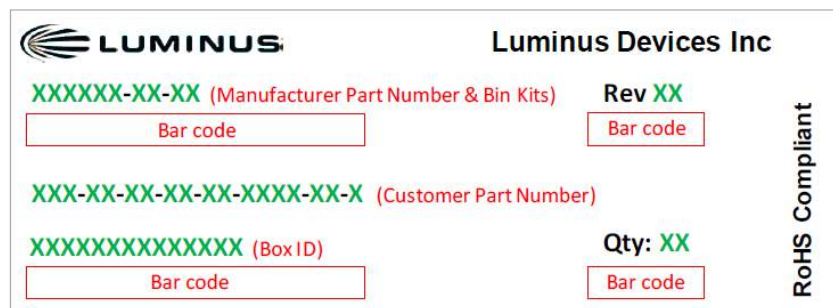

Handling Notes for Luminus COBs

Luminus products are designed for robust performance in general lighting applications; however, care must be taken when handling and assembling the LEDs into their fixtures. To avoid damaging Luminus COBs, please follow these guidelines. The following is an overview of the application notes detailing some of the practices to follow when working with these devices. More detailed information is available on the Luminus website at www.luminus.com

General Handling

Devices are made to be lifted or carried with tweezers on two “mouse bite” locations. At no time should the devices be handled by or should anything come in contact with the light emitting surface (LES) area. There are electrical connections under the LES which, if damaged, will cause the device to fail.

Static Electricity

LEDs are electronic devices which can be damaged by electrostatic discharge (ESD). Please use appropriate measures to assure the devices do not experience ESD during their handling and/or storage. ESD protection guidelines should be used at all times when working with LEDs.

Storage: Luminus products are delivered in ESD shielded bags and should be stored in these bags until used.

Assembly: Individuals handling LEDs during assembly should be trained in ESD protection practices. Assemblers should maintain constant conductive contact with a path to ground by means of a wrist strap, ankle straps, mat, or other ESD protection system.

Transporting: When transporting the devices from one assembly area to another, ESD shielded cards and carriers should be used.

Electrical Contact

Luminus COBs are designed with electrical contact pads on their top surface. These pads are clearly marked with “+” and “-” polarity. Wires can be soldered to the contact pads for electrical connections or other solderless connector products are available. If wires are being soldered to the COB product, we recommend attaching these wires prior to mounting the devices to a heat sink. Please contact Luminus for specific recommendations on how to solder wires if not familiar with the standard practice. Luminus can also offer design recommendations for jigs to enable easy soldering of multiple products in rapid succession.

Chemical Compatibility

The resin material used to form the emitters inside the LES can get hydrocarbons from the surrounding environment. As a result, certain chemical compounds are not recommended for use with Luminus products. Use of these compounds can cause damage to the light output of the device and may permanently damage the device. Please refer to www.luminus.com for a list of the compounds not recommended for use with Luminus COB products.

Thermal Interface Material (TIM)

Proper thermal management is critical for successful operation of any LED system. Excess operating temperature can reduce the light output of the device, and excessive heating can cause permanent damage to the device. Proper TIM material is a crucial component for effective heat transfer away from the LED during normal operation. Please refer to www.luminus.com for specific recommendations for TIM solutions.

Human Eye Safety

Caution must be taken not to stare at the light emitted from Luminus LEDs, as severe eye damage may occur.