

# INDICATOR LIGHTS

<b>FUNCTIONS</b>	<ul style="list-style-type: none"> <li>■ Neon or fluorescent lamp, with or without anti-luminescence resistor</li> <li>■ Incandescent lamp</li> <li>■ LED in AC or DC version</li> </ul>
<b>VOLTAGE</b>	From 2V to 400V
<b>TEMPERATURE</b>	From 75 °C to 150 °C
<b>GWT</b>	850 °C
<b>GWT NO FLAME (&lt;2sec)</b>	650 °C



S X ? ?

**SERIES**

**CUT OUT**

**DRAWING**

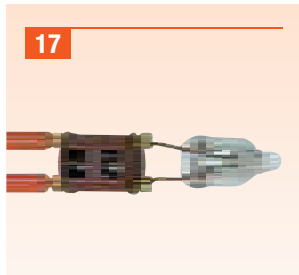

Custom

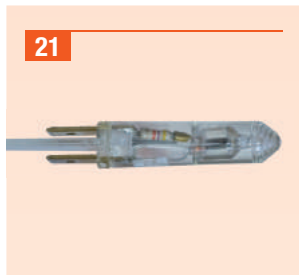
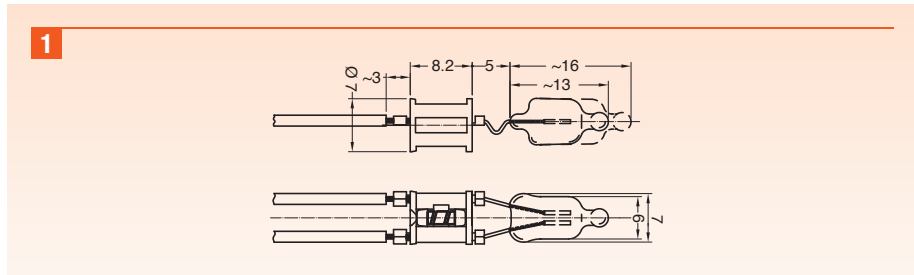

Custom

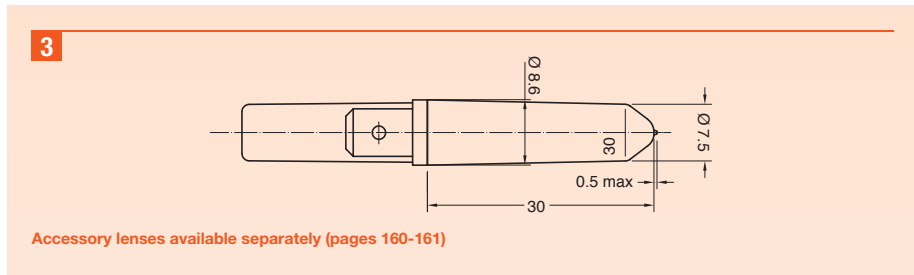

Accessory lenses available separately (pages 160-161)



5.4 x 9 mm  
th 1.5 mm

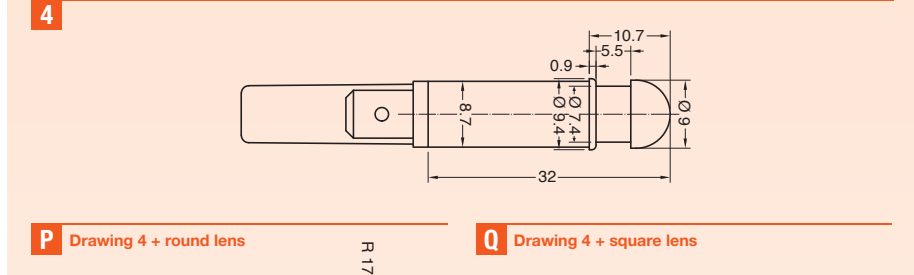

**P** Drawing 4 + round lens

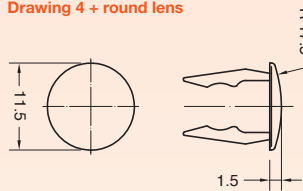

**Q** Drawing 4 + square lens

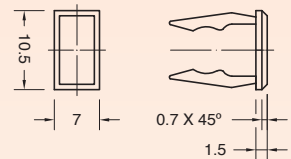

Lens available also separately SX21T542...

Lens available also separately SX21T544...

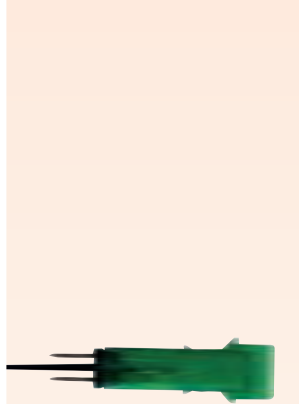

2.5 x 11.6 mm

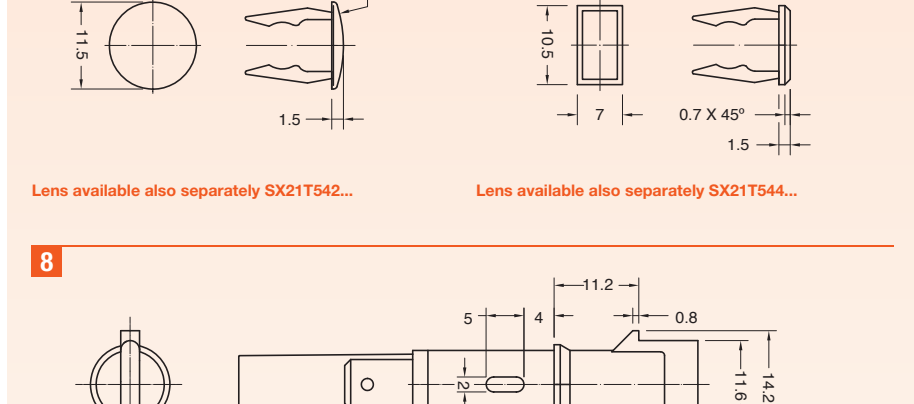

S	X	SERIES	DRAWING	TERMINAL	FUNCTION	VOLTAGE	TEMP.	COLOUR	WIRES	0	0

?	?	?	?	?	?	?	?	?	?	0	0
---	---	---	---	---	---	---	---	---	---	---	---

**TERMINAL**

**1** Series 21  
Tabs 6.3 x 0.8

**7** Series 17  
PCB terminal

**A** Series 17  
Wires

**C** Series 21  
Signal Click

**K** Series 21  
Wires crimped

**R** Series 21  
Wires sealed

**FUNCTION**

**1** Series 17 - 21

Neon or Fluorescent lamp

**2** Series 21

Neon or Fluorescent lamp with anti-luminescence

**3** Series 21

Incandescent lamp

**5** Series 21

LED  
DC or AC current  
2 ÷ 24 V

**6** Series 21  
Terminal 1

LED  
AC current  
110 ÷ 250 V

**7** Series 21  
Terminal C - K - R

LED  
AC current  
110 ÷ 250 V

**VOLTAGE**

**1** Function 5  
2 V

**2** Function 3 - 5  
12 V

**3** Function 3 - 5  
24 V

**4** Function 1 - 2 - 6 - 7  
110 V

**5** Function 1 - 2 - 6 - 7  
125 V

**6** Function 1 - 2 - 6 - 7  
230 V

**7** Function 1 - 2 - 6 - 7  
250 V

**8** Function 1 - 2  
400 V

VDE or UL certified

**?**  
Available on demand

**X**  
Custom

**TEMPERATURE**

**A**  
T 75 °C

**1** Function 1 - 2 - 3  
T 90 °C

**2** Function 1 - 2  
T 120 °C

**3** Function 1 - 2  
T 150 °C

**COLOUR**

**SERIES 17**

NO LENS ✖

**0** red light

**1** green light

**SERIES 21**

ILLUMINATED ✖

**Drawing 3 - 4**

**L** white

**Drawing P - Q - 8**

**G** red

**H** orange

**E** green

**L** white

**X** **?** custom

**WIRES**

**000** Terminal 1 - 7 - C  
Indicator light without wires

**???** Terminal A - K - R  
Indicator light with wires

**Wires Materials:**

- PVC (up to T90 °C)
- SILICONE (up to T200 °C)

**Wires Lengths:**  
from 60 mm to 600 mm (special version available up to 1.450 mm)

**Wires Ends:**

- pre-stripped (from 5.5 to 18 mm)
- stripped (from 5.5 to 18 mm)
- not stripped
- crimp terminals