

S X ? ?

?

SERIES

CUT OUT

DRAWING

41



○  
ø 12 mm  
th 0.8 ... 2 mm



○  
ø 12 mm  
th 0.8 ... 2 mm

1

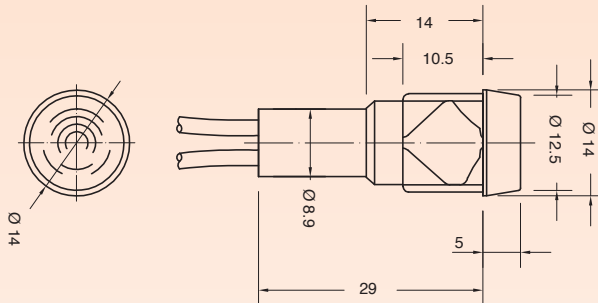

2

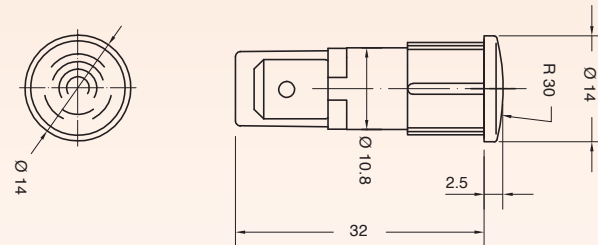

43



○  
ø 13 mm  
th 0.8 ... 2 mm

2

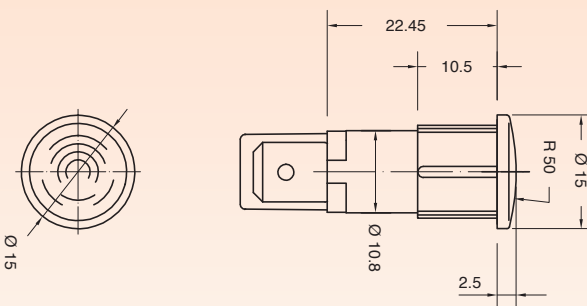

ACCESSORY LENSES FOR SERIES SX213...

SX21T511...

○  
ø 12 mm  
th 0.8 ... 6.5 mm

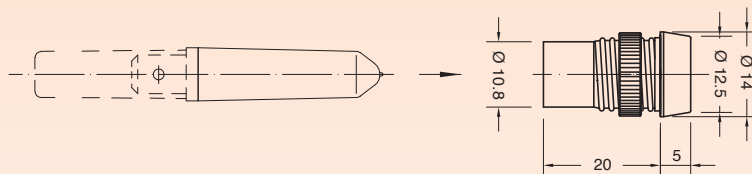

SX21T531...

○  
ø 13 mm  
th 0.8 ... 6.5 mm

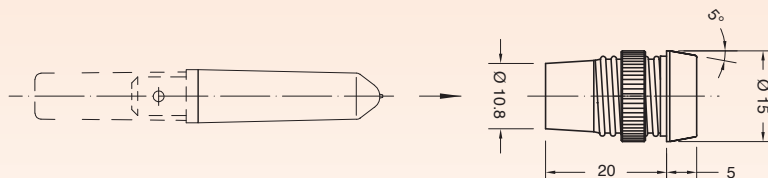

S	X	SERIES	DRAWING	TERMINAL	FUNCTION	VOLTAGE	TEMP.	COLOUR	WIRES	0	0
---	---	--------	---------	----------	----------	---------	-------	--------	-------	---	---

?	?	?	?	?	?	?	?	?	?	0	0
---	---	---	---	---	---	---	---	---	---	---	---

**TERMINAL**

**1** Series 41 - 43  
Tabs 6.3 x 0.8

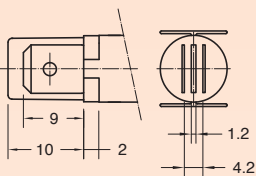

**R** Series 41  
Wires sealed

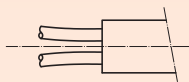

**FUNCTION**

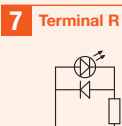
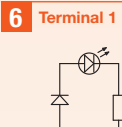
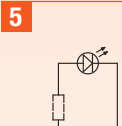
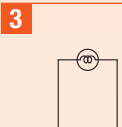
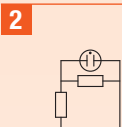
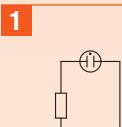

**VOLTAGE**

**1** Function 5

2 V

**2** Function 3 - 5

12 V

**3** Function 3 - 5

24 V

**4** Function 1 - 2 - 6 - 7

110 V

**5** Function 1 - 2 - 6 - 7

125 V

**6** Function 1 - 2 - 6 - 7

230 V

**7** Function 1 - 2 - 6 - 7

250 V

**8** Function 1 - 2

400 V

VDE or UL certified

**?**  
Available on demand

**X**  
Custom

**TEMPERATURE**

**A**

T 75 °C

**1** Function 1 - 2 - 3

T 90 °C

**2** Function 1 - 2

T 120 °C

**3** Function 1 - 2

T 150 °C

**COLOUR**

ILLUMINATED ✨

**G** red

**H** orange

**E** green

**L** white

**X** ?  
custom

**WIRES**

**000** Terminal 1 - C

Indicator light without wires

**???** Terminal K - R

Indicator light with wires

**Wires Material:**

- PVC (up to T90 °C)
- SILICONE (up to T200 °C)

**Wires Length:**

from 60 mm to 600 mm (special version available up to 1.450 mm)

**Wires Ends:**

- pre-stripped (from 5.5 to 18 mm)
- stripped (from 5.5 to 18 mm)
- not stripped
- crimp terminals

**SX21T572...**  
with antirotation rib

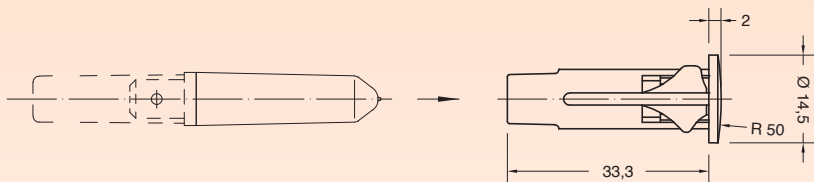
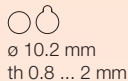

**SX21T572...**  
without antirotation rib

**SX21T592...**

