

INDICATOR LIGHTS

FUNCTIONS	<ul style="list-style-type: none"> ■ Neon or fluorescent lamp, with or without anti-luminescence resistor ■ Incandescent lamp ■ LED in AC or DC version
VOLTAGE	From 2V to 400V
TEMPERATURE	From 75 °C to 150 °C
GWT	850 °C
GWT NO FLAME (<2sec)	650 °C



S X ? ?

SERIES

CUT OUT

DRAWING

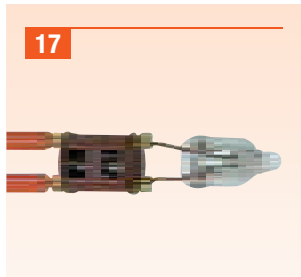

Custom

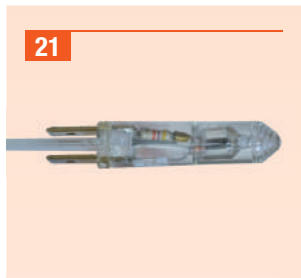
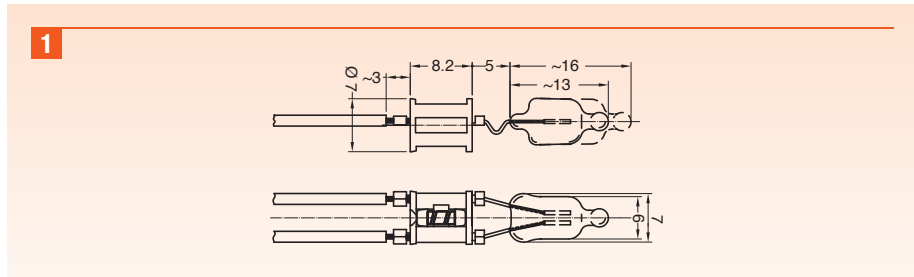

Custom

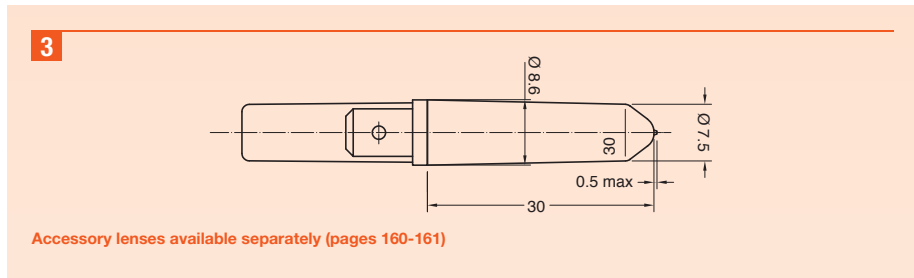

Accessory lenses available separately (pages 160-161)



5.4 x 9 mm
th 1.5 mm

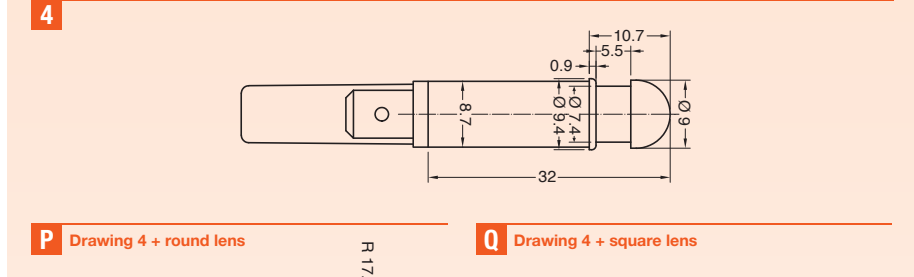

P Drawing 4 + round lens

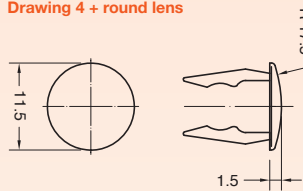

Q Drawing 4 + square lens

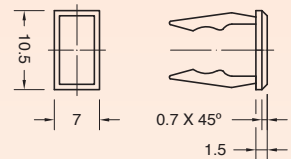

Lens available also separately SX21T542...

Lens available also separately SX21T544...



2.5 x 11.6 mm

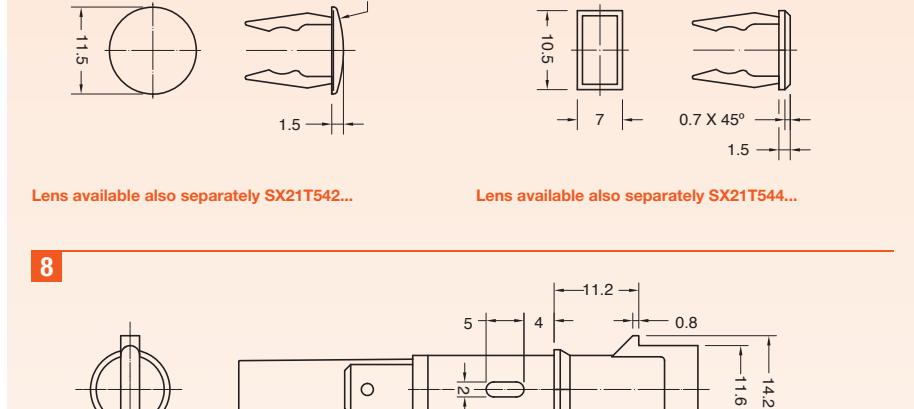

S	X	SERIES	DRAWING	TERMINAL	FUNCTION	VOLTAGE	TEMP.	COLOUR	WIRES	0	0

?	?	?	?	?	?	?	?	?	?	0	0
---	---	---	---	---	---	---	---	---	---	---	---

TERMINAL

1 Series 21
Tabs 6.3 x 0.8

7 Series 17
PCB terminal

A Series 17
Wires

C Series 21
Signal Click

K Series 21
Wires crimped

R Series 21
Wires sealed

FUNCTION

1 Series 17 - 21

Neon or Fluorescent lamp

2 Series 21

Neon or Fluorescent lamp with anti-luminescence

3 Series 21

Incandescent lamp

5 Series 21

LED
DC or AC current
2 ÷ 24 V

6 Series 21
Terminal 1

LED
AC current
110 ÷ 250 V

7 Series 21
Terminal C - K - R

LED
AC current
110 ÷ 250 V

VOLTAGE

1 Function 5
2 V

2 Function 3 - 5
12 V

3 Function 3 - 5
24 V

4 Function 1 - 2 - 6 - 7
110 V

5 Function 1 - 2 - 6 - 7
125 V

6 Function 1 - 2 - 6 - 7
230 V

7 Function 1 - 2 - 6 - 7
250 V

8 Function 1 - 2
400 V

VDE or UL certified

?
Available on demand

X
Custom

TEMPERATURE

A
T 75 °C

1 Function 1 - 2 - 3
T 90 °C

2 Function 1 - 2
T 120 °C

3 Function 1 - 2
T 150 °C

COLOUR

SERIES 17

NO LENS ✖

0 red light

1 green light

SERIES 21

ILLUMINATED ✖

Drawing 3 - 4

L white

Drawing P - Q - 8

G red

H orange

E green

L white

X **?** custom

WIRES

000 Terminal 1 - 7 - C
Indicator light without wires

??? Terminal A - K - R
Indicator light with wires

Wires Materials:

- PVC (up to T90 °C)
- SILICONE (up to T200 °C)

Wires Lengths:
from 60 mm to 600 mm (special version available up to 1.450 mm)

Wires Ends:

- pre-stripped (from 5.5 to 18 mm)
- stripped (from 5.5 to 18 mm)
- not stripped
- crimp terminals