



il futuro è iniziato ieri.

the future began yesterday.

Index

EUROPE (CEE) TYPE	06
SWISS (SEV) TYPE	12
ITALY (IMQ) TYPE	14
ENGLAND (BS) TYPE	15
AFRICA & INDIA TYPE	17
ARGENTINA (IRAM) TYPE	18
DENMARK (DEMKO) TYPE	19
ISRAEL (SI) TYPE	20
AUSTRALIA (SAA) TYPE	21
BRASIL TYPE	23
KOREA (KC) TYPE	25
CHINA (CCC) TYPE	27
JAPAN (PSE) TYPE	29
TAIWAN (BSMI) TYPE	33
AMERICAN (UL) TYPE	35
NEW TYPE	46
PLUG ADAPTERS SERIES	48
SOCKETS TYPE	50
SR	53
World Power Supply Cords Style Specification	62

>> Europe (CEE) type

Standards	Approval
HD-21: The harmonized standard for PVC insulated cables and flexible cords with rated voltage up to and including 450/750 V. IEC 227: "Polyvinyl Chloride Insulated Cables of Rated Voltages Up To and Including 450/750 V."	VDE, ÖVE, SEV, KEMA, CEBEC, IMQ SEMKO, NEMKO, DEMKO, FIMKO

• Construction

Circular Type

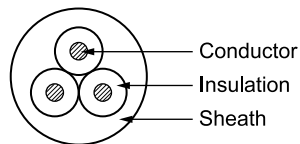

H03VV-F
H05VV-F

Flat Type

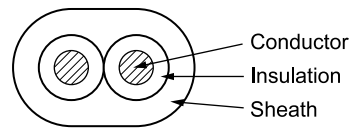









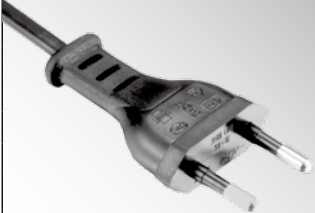









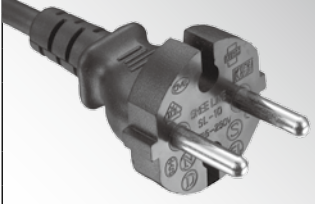





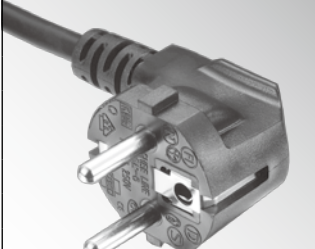









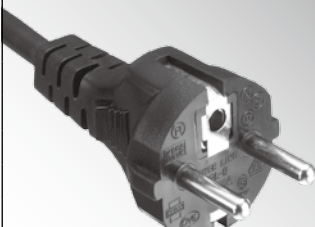

H03VVH2-F
H05VVH2-F

• Dimensions

Types	Conductor		Core	Insulation Thickness mm	Sheath Thickness mm	Overall Diameter mm	Rating		
	mm ²	No./mm					Voltage V	Temp. °C	Current A
H03VVH2-F	0.75	24/0.20	2	0.50	0.60	3.40x5.60	300/300	70	6
H03VV-F	0.75	24/0.20	2			5.60	300/300	70	6
	0.75	24/0.20	3	6.50	300/300	70	6		
H05VVH2-F	0.75	24/0.20	2	0.60	0.80	4.00x6.40	300/500	70	6
	1.00	32/0.20				4.30x6.70	300/500	70	10
H05VV-F	0.75	24/0.20	2	0.70	0.80	6.50	300/500	70	6
	1.00	32/0.20				6.70	300/500	70	10
	1.50	30/0.25				7.80	300/500	70	16
	2.50	50/0.25				9.80	300/500	70	20
	0.75	24/0.20	3	0.60	0.80	6.80	300/500	70	6
	1.00	32/0.20				7.00	300/500	70	10
	1.50	30/0.25				8.50	300/500	70	16
	2.50	50/0.25				10.30	300/500	70	20
H05RR-F	0.75	24/0.20	2	0.60	0.80	6.20	300/500	60	6
	1.00	32/0.20		0.60	0.90	6.80	300/500	60	10
	1.50	30/0.25		0.80	1.00	8.30	300/500	60	16
	0.75	24/0.20	3	0.60	0.90	6.70	300/500	60	6
	1.00	32/0.20		7.10	300/500	60	10		
	1.50	30/0.25		8.75	300/500	60	16		
H05RN-F	0.75	24/0.20	2	0.60	0.80	6.20	300/500	60	6
	1.00	32/0.20			0.90	6.80	300/500	60	10
	0.75	24/0.20	3		0.90	6.70	300/500	60	6
	1.00	32/0.20			0.90	7.10	300/500	60	10
H07RN-F	1.00	32/0.20	2	0.80	1.30	8.40	450/750	60	10
	1.50	30/0.25			1.50	9.30	450/750	60	16
	2.50	50/0.25			1.70	10.80	450/750	60	20
	1.00	32/0.20	3	0.80	1.40	9.00	450/750	60	10
	1.50	30/0.25			1.60	9.90	450/750	60	16
	2.50	50/0.25			1.80	11.80	450/750	60	20

>> Europe (CEE) type

Style	Type No.	Standard	Available with Cords		Approvals
	QP-009	IEC 60884-1/EN50075	H03VVH2-F2X0.75mm ²	2.5A 250V	        
			H05VVH2-F2X0.75mm ²	2.5A 250V	
	QP-014	IEC 60884-1/CEE 7-XVII	H03VVH2-F 2X 0.75mm ²	16A 250V	     
			H05VVH2-F 2X 0.75mm ²	16A 250V	
			H03VV-F 2X 0.75mm ²	16A 250V	
			H05VV-F 2X 0.75mm ²	16A 250V	
			H05VV-F 2X 1.00mm ²	16A 250V	
			H05VV-F 2X 1.50mm ²	16A 250V	
			H05RR-F 2X 0.75mm ²	16A 250V	
			H05RR-F 2X 1.00mm ²	16A 250V	
			H05RN-F 2X 0.75mm ²	16A 250V	
			H05RN-F 2X 1.00mm ²	16A 250V	
			H07RN-F 2X 1.00mm ²	16A 250V	
			H07RN-F 2X 1.50mm ²	16A 250V	
	QP-004	IEC 60884-1/CEE 7-VII	H03VV-F 3G 0.75mm ²	16A 250V	        
			H05VV-F 3G 0.75mm ²	16A 250V	
			H05VV-F 3G 1.00mm ²	16A 250V	
			H05VV-F 3G 1.50mm ²	16A 250V	
			H05RR-F 3G 0.75mm ²	16A 250V	
			H05RR-F 3G 1.00mm ²	16A 250V	
			H05RR-F 3G 1.50mm ²	16A 250V	
			H05RN-F 3G 0.75mm ²	16A 250V	
			H05RN-F 3G 1.00mm ²	16A 250V	
	QP-006	IEC 60884-1/CEE 7-VII	H03VV-F 3G 0.75mm ²	16A 250V	        
			H05VV-F 3G 0.75mm ²	16A 250V	
			H05VV-F 3G 1.00mm ²	16A 250V	
			H05VV-F 3G 1.50mm ²	16A 250V	
			H05RR-F 3G 0.75mm ²	16A 250V	
			H05RR-F 3G 1.00mm ²	16A 250V	
			H05RR-F 3G 1.50mm ²	16A 250V	
			H05RN-F 3G 0.75mm ²	16A 250V	
			H05RN-F 3G 1.00mm ²	16A 250V	







































QP-009

QP-014





QP-004

QP-006

>> Europe (CEE) type

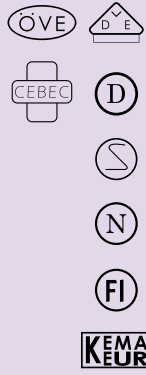
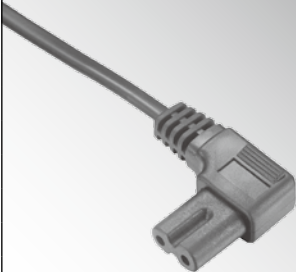
Style	Type No.	Standard	Available with Cords		Approvals
	QP-007	EN/IEC 60320-1 C13	H05VV-F 3G 0.75mm ²	10A 250V	         
			H05VV-F 3G 1.00mm ²	10A 250V	
	QP-018	EN/IEC 60320-1 C13	H05VV-F 3G 0.75mm ²	10A 250V	         
			H05VV-F 3G 1.00mm ²	10A 250V	
	QP-015	EN/IEC 60320 C14	H05VV-F 3G 0.75mm ²	10A 250V	        
			H05VV-F 3G 1.00mm ²	10A 250V	
	QP-046	EN/IEC 60320 C14	H05VV-F 3G 0.75mm ²	10A 250V	    
			H05VV-F 3G 1.00mm ²	10A 250V	

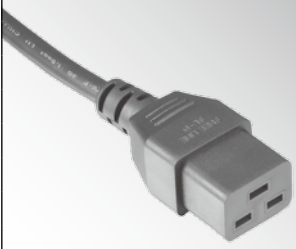
>> Europe (CEE) type

Style	Type No.	Standard	Available with Cords		Approvals
	QP-038	EN/IEC 60320-1 C5	H03VV-F 3G 0.75mm ²	2.5A 250V	
			H05VV-F 3G 0.75mm ²	2.5A 250V	
	QP-045R	EN/IEC 60320-1 C7	H03VVH2-F 2X 0.75mm ²	2.5A 250V	
			H05VVH2-F 2X 0.75mm ²	2.5A 250V	
	QP-051	EN/IEC 60320 C20	H05VV-F 3G 1.00mm ²	16A 250V	
			H05VV-F 3G 1.50mm ²	16A 250V	
	QP-052	EN/IEC 60320-1 C19	H05VV-F 3G 1.00mm ²	16A 250V	
			H05VV-F 3G 1.50mm ²	16A 250V	





QP-038

QP-045R

QP-051

QP-052

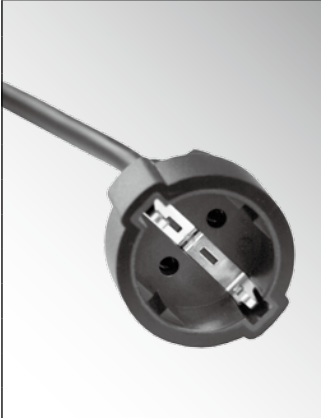
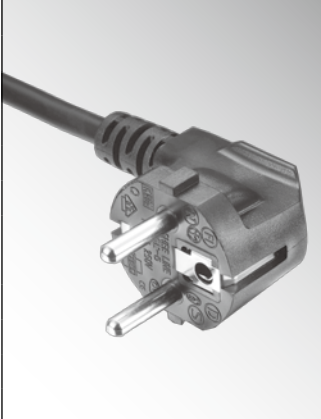
>> Europe (CEE) type



Style	Type No.	Standard	Available with Cords		Approvals
	QP-068	EN/IEC 60320-1 C15	H05RR-F 3G 0.75mm ²	10A 250V	
			H05RR-F 3G 1.00mm ²	10A 250V	
			H05RN-F 3G 0.75mm ²	10A 250V	
			H05RN-F 3G 1.00mm ²	10A 250V	
	QP-100	CEE 7-III	H05VV-F 3G 1.50mm ²	16A 250V	
	QP-004-1	IEC60884/EN50075	H03Z1Z1-F 3G 0.75mm ²	16A 250V	
			H05Z1Z1-F 3G 0.75mm ²	16A 250V	
			H05Z1Z1-F 3G 1.0mm ²	16A 250V	
			H05Z1Z1-F 3G 1.5mm ²	16A 250V	

QP-068





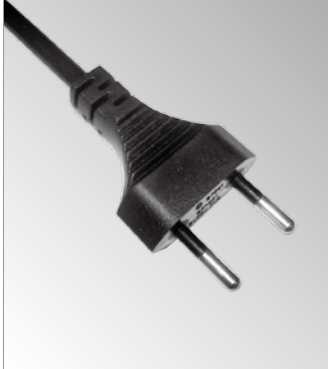
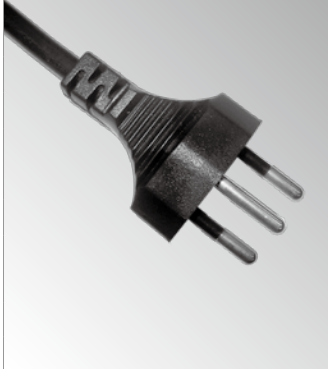

QP-100

QP-004-1

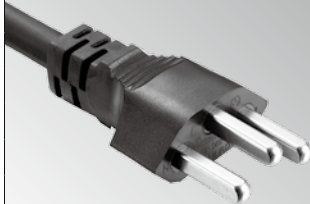
>> Swiss (SEV) type

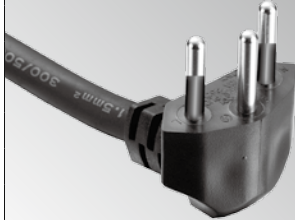
Style	Type No.	Standard	Available with Cords		Approvals
	QP-021 Insulated Pin	SEV 1011/IEC 60884-1	H03VV-F 2X 0.75mm ²	10A 250V	(+) S
			H05VV-F 2X 0.75mm ²	10A 250V	
			H05VV-F 2X 1.00mm ²	10A 250V	
	QP-022 Insulated Pin	SEV 1011/IEC 60884-1	H03VV-F 3G 0.75mm ²	10A 250V	(+) S
			H05VV-F 3G 0.75mm ²	10A 250V	
			H05VV-F 3G 1.00mm ²	10A 250V	
			H05VV-F 3G 1.50mm ²	10A 250V	
			H05RR-F 3G 0.75mm ²	10A 250V	
			H05RR-F 3G 1.00mm ²	10A 250V	
			H05RN-F 3G 0.75mm ²	10A 250V	
			H05RN-F 3G 1.00mm ²	10A 250V	
	PLUG: QP-022	SEV 1011/IEC 60884-1 EN/IEC 60320-1 C13	H05VV-F 3G 0.75mm ²	10A 250V	(+) S
	Connector: QP-007		H05VV-F 3G 1.00mm ²	10A 250V	
	PLUG: QP-022	SEV 1011/IEC 60884-1 EN/IEC 60320-1 C13	H05VV-F 3G 0.75mm ²	10A 250V	(+) S
	Connector: QP-018		H05VV-F 3G 1.00mm ²	10A 250V	

>> Swiss (SEV) type







Style	Type No.	Standard	Available with Cords		Approvals
	QP-089	SEV 1011/IEC 60884-1	H03VV-F 3G 0.75mm ²	16A 250V	
			H05VV-F 3G 0.75mm ²	16A 250V	
			H05VV-F 3G 1.00mm ²	16A 250V	
			H05VV-F 3G 1.50mm ²	16A 250V	
			H05RR-F 3G 0.75mm ²	16A 250V	
			H05RR-F 3G 1.00mm ²	16A 250V	
			H05RR-F 3G 1.50mm ²	16A 250V	
			H05RN-F 3G 0.75mm ²	16A 250V	
			H05RN-F 3G 1.00mm ²	16A 250V	
			H07RN-F 3G 1.00mm ²	16A 250V	
			H07RN-F 3G 1.50mm ²	16A 250V	
	QP-091 Insulated Pin	SEV 1011/IEC 60884-1	H03VV-F 3G 0.75mm ²	10A 250V	
			H05VV-F 3G 0.75mm ²	10A 250V	
			H05VV-F 3G 1.00mm ²	10A 250V	
			H05VV-F 3G 1.50mm ²	10A 250V	
			H05RR-F 3G 0.75mm ²	10A 250V	
			H05RR-F 3G 1.00mm ²	10A 250V	
			H05RR-F 3G 1.50mm ²	10A 250V	
			H05RN-F 3G 0.75mm ²	10A 250V	
			H05RN-F 3G 1.00mm ²	10A 250V	
			H07RN-F 3G 1.00mm ²	10A 250V	
			H07RN-F 3G 1.50mm ²	10A 250V	
	QP-096	SEV 1011/IEC 60884-1	H05VV-F 3G 0.75mm ²	10A 250V	
			H05VV-F 3G 1.00mm ²	10A 250V	
			H05VV-F 3G 1.50mm ²	10A 250V	
			H05RR-F 3G 0.75mm ²	10A 250V	
			H05RR-F 3G 1.00mm ²	10A 250V	
			H05RR-F 3G 1.50mm ²	10A 250V	
			H05RN-F 3G 0.75mm ²	10A 250V	
			H05RN-F 3G 1.00mm ²	10A 250V	

QP-089

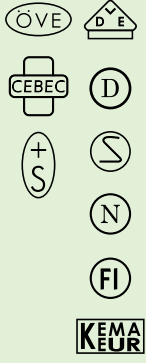
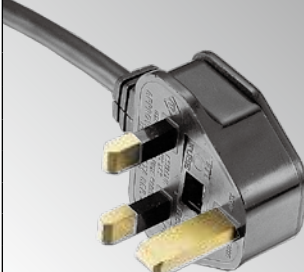
QP-091

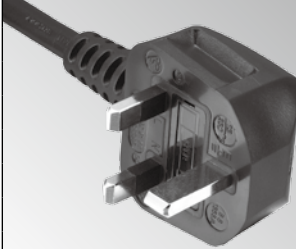
QP-096

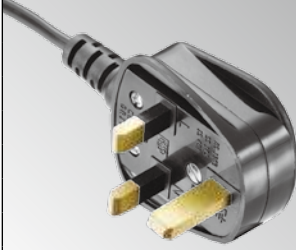
>> England (BS) type

Style	Type No.	Standard	Available with Cords		Approvals
	QP-015	EN/IEC 60320 C14	H05VV-F 3G 0.75mm ²	10A 250V	
			H05VV-F 3G 1.00mm ²	10A 250V	
	QP-025 (Ultrasonic)	BS-1363	H03VVH2-F 2X 0.75mm ²	3-13A 250V	
			H05VVH2-F 2X 0.75mm ²	3-13A 250V	
			H03VV-F 2/3G 0.75mm ²	3-13A 250V	
			H05VV-F 2/3G 0.75mm ²	3-13A 250V	
			H05VV-F 2/3G 1.00mm ²	3-13A 250V	
	QP-026 (Molding)	BS-1363	H03VVH2-F 2X 0.75mm ²	3-13A 250V	 BS 1363
			H05VVH2-F 2X 0.75mm ²	3-13A 250V	
			H03VV-F 2/3G 0.75mm ²	3-13A 250V	
			H05VV-F 2/3G 0.75mm ²	3-13A 250V	
			H05VV-F 2/3G 1.00mm ²	3-13A 250V	
			H05VV-F 2/3G 1.50mm ²	3-13A 250V	
			H05RR-F 2/3G 0.75mm ²	3-13A 250V	
			H05RR-F 2/3G 1.00mm ²	3-13A 250V	
			H05RR-F 2/3G 1.50mm ²	3-13A 250V	
			H05RN-F 2/3G 0.75mm ²	3-13A 250V	
			H05RN-F 2/3G 1.00mm ²	3-13A 250V	
			H07RN-F 2/3G 1.00mm ²	3-13A 250V	
			H07RN-F 2/3G 1.50mm ²	3-13A 250V	
	QP-001 (Assembly)	BS-1363	H03VVH2-F 2X 0.75mm ²	3-13A 250V	
			H05VVH2-F 2X 0.75mm ²	3-13A 250V	
			H03VV-F 2/3G 0.75mm ²	3-13A 250V	
			H05VV-F 2/3G 0.75mm ²	3-13A 250V	
			H05VV-F 2/3G 1.00mm ²	3-13A 250V	
			H05VV-F 2/3G 1.50mm ²	3-13A 250V	
			H05RR-F 2/3G 0.75mm ²	3-13A 250V	
			H05RR-F 2/3G 1.00mm ²	3-13A 250V	
			H05RR-F 2/3G 1.50mm ²	3-13A 250V	
			H05RN-F 2/3G 0.75mm ²	3-13A 250V	
			H05RN-F 2/3G 1.00mm ²	3-13A 250V	
			H07RN-F 2/3G 1.00mm ²	3-13A 250V	
			H07RN-F 2/3G 1.50mm ²	3-13A 250V	

QP-015

QP-025

QP-026

QP-001

QP-015
QP-007

QP-026
QP-045





QP-026
QP-007

QP-020
QP-007

>> England (BS) type

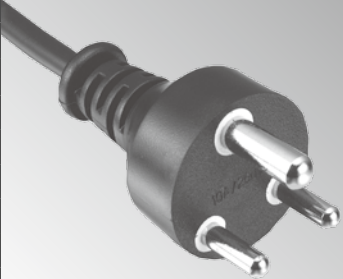
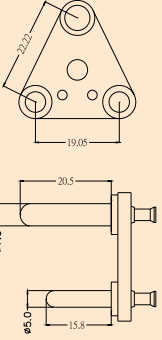
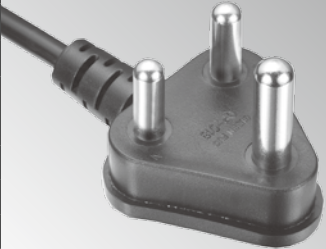
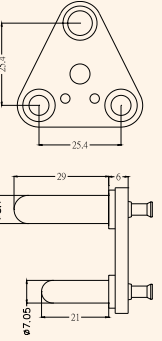
Style	Type No.	Standard	Available with Cords		Approvals
	PLUG: QP-015	EN/IEC 60320 C14 EN/IEC 60320-1 C13	H05VV-F 3G 0.75mm ²	10A 250V	
	Connector: QP-007		H05VV-F 3G 1.00mm ²	10A 250V	
	PLUG: QP-001 QP-025 QP-026	BS-1363 EN/IEC 60320-1 C7	H03VVH2-F 2X 0.75mm ²	3-13A 250V	
	Connector: QP-045		H05VVH2-F 2X 0.75mm ²	3-13A 250V	
	PLUG: QP-001 QP-025 QP-026	BS-1363 EN/IEC 60320-1 C13	H05VV-F 3G 0.75mm ²	3-13A 250V	
	Connector: QP-007		H05VV-F 3G 1.00mm ²	3-13A 250V	
	PLUG: QP-020	EN/IEC 60320-1 C13	H03VV-F 3G 0.75mm ²	3-13A 250V	NON Approvals
	Connector: QP-007		H05VV-F 3G 0.75mm ²	3-13A 250V	
			H05VV-F 3G 1.00mm ²	3-13A 250V	

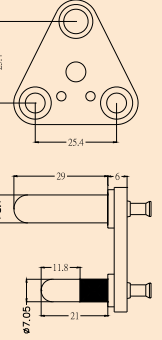
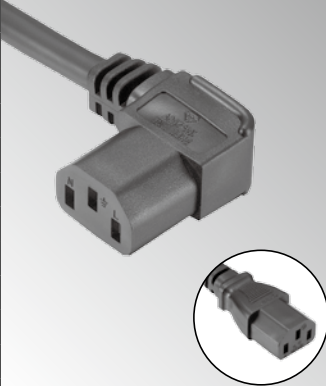
>> Africa & India type

Style	Type No.	Standard	Available with Cords	Approvals
 <p>For Africa & India</p>	QP-023	BS-546 	H03VV-F 3G 0.75mm ² 10A 250V	
			H05VV-F 3G 0.75mm ² 10A 250V	
			H05VV-F 3G 1.00mm ² 10A 250V	
			H05VV-F 3G 1.50mm ² 10A 250V	
 <p>For Africa</p>	QP-013		H03VV-F 3G 0.75mm ² 16A 250V	
			H05VV-F 3G 0.75mm ² 16A 250V	
			H05VV-F 3G 1.00mm ² 16A 250V	
			H05VV-F 3G 1.50mm ² 16A 250V	
 <p>For Africa</p>	QP-013-1 (Insulated Pin)		H03VV-F 3G 0.75mm ² 16A 250V	
			H05VV-F 3G 0.75mm ² 16A 250V	
			H05VV-F 3G 1.00mm ² 16A 250V	
			H05VV-F 3G 1.50mm ² 16A 250V	
	QP-018 QP-007	EN/IEC 60320-1 C13	H05VV-F 3G 0.75mm ² 10A 250V	
			H05VV-F 3G 1.00mm ² 10A 250V	







QP-023

QP-013

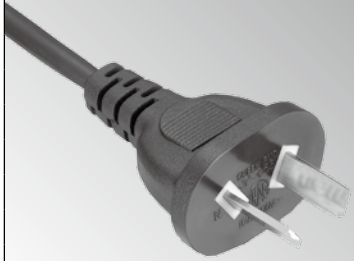

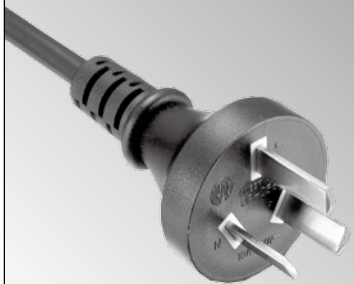
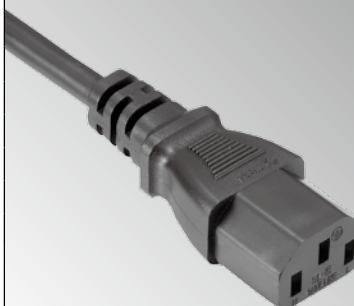



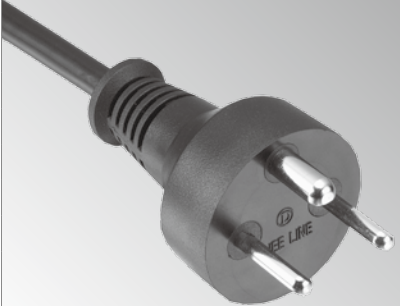
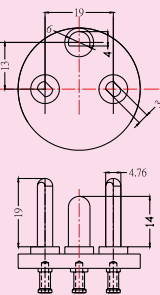

QP-013-1
Insulated
Pin

QP-018
QP-007

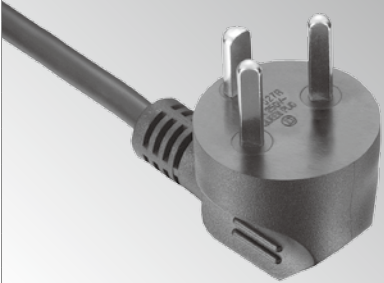
>> Argentina (IRAM) type

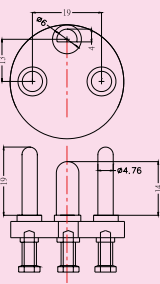
Style	Type No.	Standard	Available with Cords		Approvals
	QP-047	IRAM 2063 IEC 60884-1	H03VVH2-F 2X 0.75mm ²	10A 250V	 IRAM-ITS-IMQ (P)S.A
			H05VVH2-F 2X 0.75mm ²	10A 250V	
			H03VV-F 2X 0.75mm ²	10A 250V	
			H05VV-F 2X 0.75mm ²	10A 250V	
			H05VV-F 2X 1.00mm ²	10A 250V	
			H05VV-F 2X 1.50mm ²	10A 250V	
			H05RR-F 2X 0.75mm ²	10A 250V	
			H05RR-F 2X 1.00mm ²	10A 250V	
			H05RN-F 2X 0.75mm ²	10A 250V	
			H05RN-F 2X 1.00mm ²	10A 250V	
				QP-048	
H05VV-F 3G 0.75mm ²	10A 250V				
H05VV-F 3G 1.00mm ²	10A 250V				
H05VV-F 3G 1.50mm ²	10A 250V				
H05RR-F 3G 0.75mm ²	10A 250V				
H05RR-F 3G 1.00mm ²	10A 250V				
H05RR-F 3G 1.50mm ²	10A 250V				
H05RN-F 3G 0.75mm ²	10A 250V				
H05RN-F 3G 1.00mm ²	10A 250V				
	QP-007	EN/IEC 60320-1 C13	H05VV-F 3G 0.75mm ²	10A 250V	 IRAM-ITS-IMQ (P)S.A
			H05VV-F 3G 1.00mm ²	10A 250V	
			H05VV-F 3G 1.50mm ²	10A 250V	
	QP-045	EN/IEC 60320-1 C7	H03VVH2-F 2X 0.75mm ²	2.5A 250V	
			H05VVH2-F 2X 0.75mm ²	2.5A 250V	

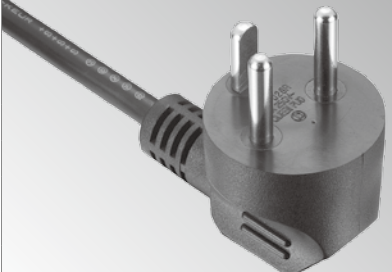
>> Denmark (DEMKO) type

Style	Type No.	Standard	Available with Cords		Approvals
	QP-027	SB 107-2-D1 2-5a 	H03VV-F 3G 0.75mm ²	10A 250V	
			H05VV-F 3G 0.75mm ²	10A 250V	
			H05VV-F 3G 1.00mm ²	10A 250V	
			H05VV-F 3G 1.50mm ²	10A 250V	
			H05RR-F 3G 0.75mm ²	10A 250V	
			H05RR-F 3G 1.00mm ²	10A 250V	
			H05RN-F 3G 0.75mm ²	10A 250V	
			H05RN-F 3G 1.00mm ²	10A 250V	
	QP-027R	SB 107-2-D1	H03VV-F 3G 0.75mm ²	10A 250V	
			H05VV-F 3G 0.75mm ²	10A 250V	
			H05VV-F 3G 1.00mm ²	10A 250V	
			H05VV-F 3G 1.50mm ²	10A 250V	
			H05RR-F 3G 0.75mm ²	10A 250V	
			H05RR-F 3G 1.00mm ²	10A 250V	
			H05RN-F 3G 0.75mm ²	10A 250V	
			H05RN-F 3G 1.00mm ²	10A 250V	
	QP-028	SB 107-2-D1 2-1a 	H03VV-F 3G 0.75mm ²	10A 250V	
			H05VV-F 3G 0.75mm ²	10A 250V	
			H05VV-F 3G 1.00mm ²	10A 250V	
			H05VV-F 3G 1.50mm ²	10A 250V	
			H05RR-F 3G 0.75mm ²	10A 250V	
			H05RR-F 3G 1.00mm ²	10A 250V	
			H05RN-F 3G 0.75mm ²	10A 250V	
			H05RN-F 3G 1.00mm ²	10A 250V	
	QP-028R	SB 107-2-D1	H03VV-F 3G 0.75mm ²	10A 250V	
			H05VV-F 3G 0.75mm ²	10A 250V	
			H05VV-F 3G 1.00mm ²	10A 250V	
			H05VV-F 3G 1.50mm ²	10A 250V	
			H05RR-F 3G 0.75mm ²	10A 250V	
			H05RR-F 3G 1.00mm ²	10A 250V	
			H05RN-F 3G 0.75mm ²	10A 250V	
			H05RN-F 3G 1.00mm ²	10A 250V	









QP-027

QP-027R

QP-028

QP-028R

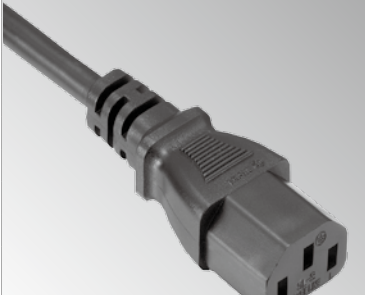
>> Australia (SAA) type

Style	Type No.	Standard	Available with Cords		Approvals
	QP-002	AS/NZS 3112	H03VVH2-F 2X 0.75mm ²	7.5A 250V	
			H05VVH2-F 2X 0.75mm ²	7.5A 250V	
			H05VVH2-F 2X 1.00mm ²	10A 250V	
			H03VV-F 2X 0.75mm ²	7.5A 250V	
			H05VV-F 2X 0.75mm ²	7.5A 250V	
			H05VV-F 2X 1.00mm ²	10A 250V	
			H05RR-F 2X 0.75mm ²	7.5A 250V	
			H05RR-F 2X 1.00mm ²	10A 250V	
			H05RN-F 2X 0.75mm ²	7.5A 250V	
			H05RN-F 2X 1.00mm ²	10A 250V	
	QP-003	AS/NZS 3112	H03VV-F 3G 0.75mm ²	10A 250V	
			H05VV-F 3G 0.75mm ²	10A 250V	
			H05VV-F 2X 1.00mm ²	10A 250V	
			H05VV-F 3G 1.00mm ²	10A 250V	
			H05VV-F 3G 1.50mm ²	15A 250V	
			H05RR-F 3G 0.75mm ²	10A 250V	
			H05RR-F 3G 1.00mm ²	10A 250V	
			H05RR-F 3G 1.50mm ²	15A 250V	
			H05RN-F 3G 0.75mm ²	10A 250V	
			H05RN-F 3G 1.00mm ²	10A 250V	
	QP-015	AS/NZS 3109.1 C14	H05VV-F 3G 0.75mm ²	10A 250V	
			H05VV-F 3G 1.00mm ²	10A 250V	
	QP-007	AS/NZS 3109.1 C13	H05VV-F 3G 0.75mm ²	10A 250V	
			H05VV-F 3G 1.00mm ²	10A 250V	







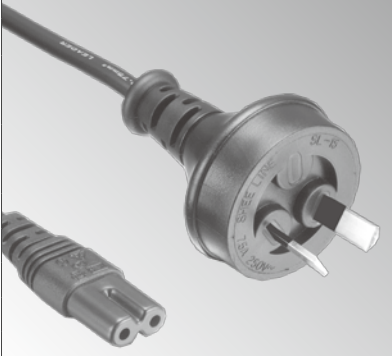

QP-002

QP-003

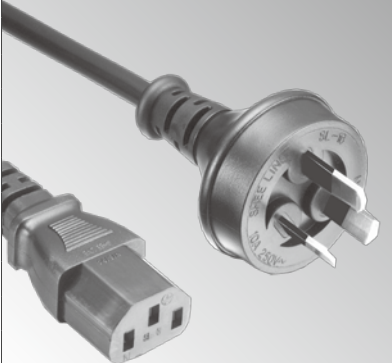

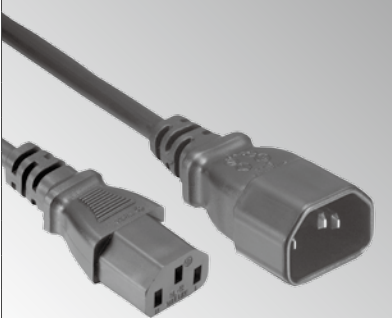

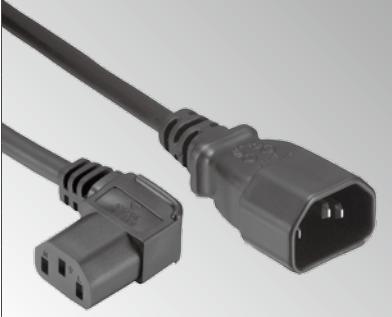

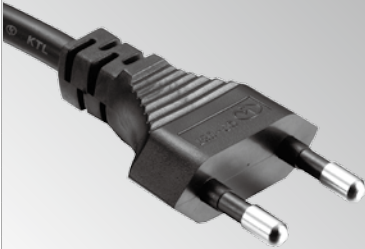

QP-015

QP-007

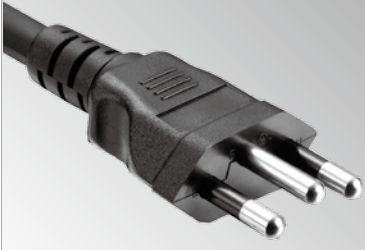
>> Australia (SAA) type

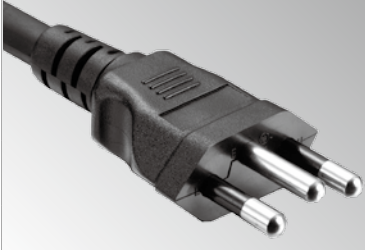
Style	Type No.	Standard	Available with Cords		Approvals
	PLUG: QP-002	AS/NZS 3112 AS/NZS 3109.1 C7	H03VVH2-F 2X 0.75mm ²	2.5A 250V	
	Connector: QP-045		H05VVH2-F 2X 0.75mm ²	2.5A 250V	
	PLUG: QP-003	AS/NZS 3112 AS/NZS 3109.1 C13	H05VV-F 3G 0.75mm ²	10A 250V	
	Connector: QP-007		H05VV-F 3G 1.00mm ²	10A 250V	
	PLUG: QP-015	AS/NZS 3109.1 C14 AS/NZS 3109.1 C13	H05VV-F 3G 0.75mm ²	10A 250V	
	Connector: QP-007		H05VV-F 3G 1.00mm ²	10A 250V	
	PLUG: QP-015	AS/NZS 3109.1 C14 EN/IEC 60320-1 C13	H05VV-F 3G 0.75mm ²	10A 250V	
	Connector: QP-018 (VDE)		H05VV-F 3G 1.00mm ²	10A 250V	

>> Brasil type

Style	Type No.	Standard	Available with Cords		Approvals	
	QP-083	ABNT NBR NM 60884-1 NBR14136 Φ=4.0mm	H03VVH2-F	2X 0.75mm ²	10A 250V	 
			H05VVH2-F	2X 0.75mm ²	10A 250V	
			H05VVH2-F	2X 1.00mm ²	10A 250V	
			H03VV-F	2X 0.50mm ²	10A 250V	
			H03VV-F	2X 0.75mm ²	10A 250V	
			H05VV-F	2X 0.75mm ²	10A 250V	
			H05VV-F	2X 1.00mm ²	10A 250V	
			H05VV-F	2X 1.50mm ²	10A 250V	
			H03RT-H	2X 0.75mm ²	10A 250V	
			H03RT-H	2X 1.00mm ²	10A 250V	
			H05RR-F	2X 0.75mm ²	10A 250V	
			H05RR-F	2X 1.00mm ²	10A 250V	
			H05RR-F	2X 1.50mm ²	10A 250V	
			H05RN-F	2X 0.75mm ²	10A 250V	
H05RN-F	2X 1.00mm ²	10A 250V				
H07RN-F	2X 1.00mm ²	10A 250V				
	QP-084	ABNT NBR NM 60884-1 NBR14136 Φ=4.0mm	H03VV-F	3G 0.75mm ²	10A 250V	 
			H05VV-F	3G 0.75mm ²	10A 250V	
			H05VV-F	3G 1.00mm ²	10A 250V	
			H05VV-F	3G 1.50mm ²	10A 250V	
			H03RT-H	3G 0.75mm ²	10A 250V	
			H03RT-H	3G 1.00mm ²	10A 250V	
			H05RN-F	3G 0.75mm ²	10A 250V	
			H05RN-F	3G 1.00mm ²	10A 250V	
			H05RR-F	3G 0.75mm ²	10A 250V	
			H05RR-F	3G 1.00mm ²	10A 250V	
			H05RR-F	3G 1.50mm ²	10A 250V	
			H07RN-F	3G 1.00mm ²	10A 250V	
			H07RN-F	3G 1.50mm ²	10A 250V	
				QP-085	ABNT NBR NM 60884-1 NBR14136 Φ=4.8mm	
H05VV-F	3G 2.50mm ²	20A 250V				
H05RR-F	3G 1.50mm ²	16A 250V				
H07RN-F	3G 1.50mm ²	16A 250V				
H07RN-F	3G 2.50mm ²	20A 250V				
	QP-015	EN/IEC 60320 C14	H05VV-F	3G 0.75mm ²	10A 250V	 
			H05VV-F	3G 1.00mm ²	10A 250V	







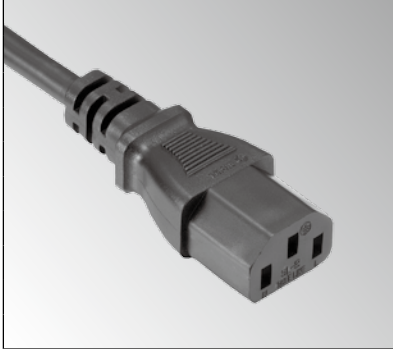

QP-083

QP-084

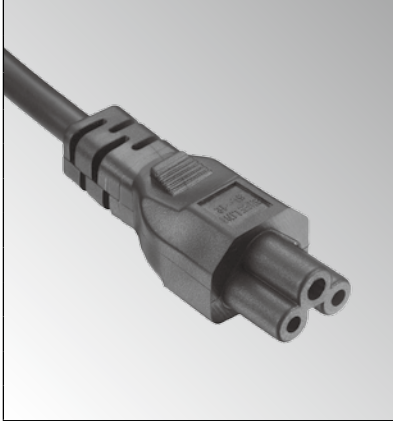





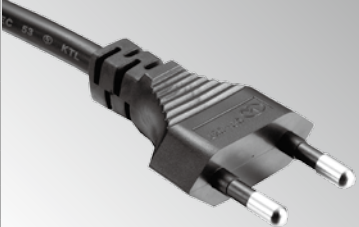

QP-085

QP-015

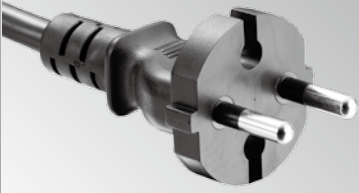
>> Brasil type

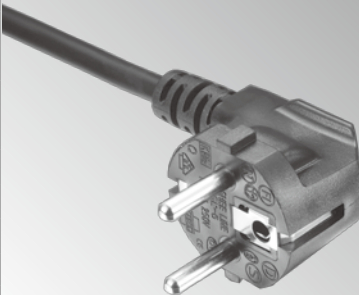
Style	Type No.	Standard	Available with Cords		Approvals
	QP-007	IEC 60320-1	H05VV-F 3G 0.75mm ²	10A 250V	 
			H05VV-F 3G 1.00mm ²	10A 250V	
	QP-038	IEC 60320-1	H03VV-F 3G 0.75mm ²	2.5A 250V	 
			H05VV-F 3G 0.75mm ²	2.5A 250V	
			H05VV-F 3G 1.00mm ²	2.5A 250V	
	QP-045	IEC 60320-1	H03VVH2-F 2X 0.75mm ²	2.5A 250V	 
			H05VVH2-F 2X 0.75mm ²	2.5A 250V	

>> Korea (KC) type

Style	Type No.	Standard	Available with Cords		Approvals	
	QP-087	K60884-1/KSC8305 Φpin=4.8mm	H03VVH2-F	2X 0.75mm ²	2.5A 250V	
			H05VVH2-F	2X 0.75mm ²	2.5A 250V	
			H05VVH2-F	2X 1.00mm ²	2.5A 250V	
			H03VV-F	2X 0.75mm ²	2.5A 250V	
			H05VV-F	2X 0.75mm ²	2.5A 250V	
			H05VV-F	2X 1.00mm ²	2.5A 250V	
			H05RR-F	2X 0.75mm ²	2.5A 250V	
			H05RR-F	2X 1.00mm ²	2.5A 250V	
			H05RN-F	2X 0.75mm ²	2.5A 250V	
			H05RN-F	2X 1.00mm ²	2.5A 250V	
	QP-088	KSC8305/K60884-1 Φpin=4.8mm	H03VVH2-F	2X 0.75mm ²	16A 250V	
			H05VVH2-F	2X 0.75mm ²	16A 250V	
			H05VVH2-F	2X 1.00mm ²	16A 250V	
			H03VV-F	2X 0.75mm ²	16A 250V	
			H05VV-F	2X 0.75mm ²	16A 250V	
			H05VV-F	2X 1.00mm ²	16A 250V	
			H05VV-F	2X 1.50mm ²	16A 250V	
			H05RR-F	2X 0.75mm ²	16A 250V	
			H05RR-F	2X 1.00mm ²	16A 250V	
			H05RR-F	2X 1.50mm ²	16A 250V	
			H05RN-F	2X 0.75mm ²	16A 250V	
			H05RN-F	2X 1.00mm ²	16A 250V	
			H07RN-F	2X 1.00mm ²	16A 250V	
			H07RN-F	2X 1.50mm ²	16A 250V	
	QP-004	KSC8305/K60884-1	H03VV-F	3G 0.75mm ²	16A 250V	
			H05VV-F	3G 0.75mm ²	16A 250V	
			H05VV-F	3G 1.00mm ²	16A 250V	
			H05VV-F	3G 1.50mm ²	16A 250V	
			H05RR-F	3G 0.75mm ²	16A 250V	
			H05RR-F	3G 1.00mm ²	16A 250V	
			H05RR-F	3G 1.50mm ²	16A 250V	
			H05RN-F	3G 0.75mm ²	16A 250V	
			H05RN-F	3G 1.00mm ²	16A 250V	
	QP-015	K60320-2-2/ K60320-1	H05VV-F	3G 0.75mm ²	10A 250V	
			H05VV-F	3G 1.00mm ²	10A 250V	







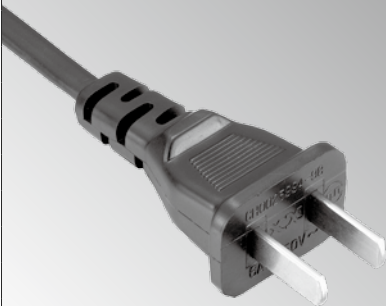

QP-087

QP-088

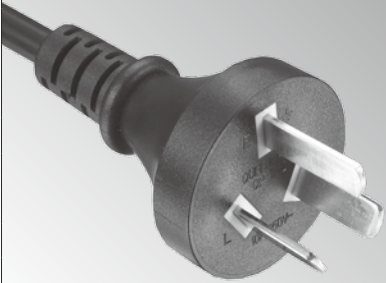
QP-004

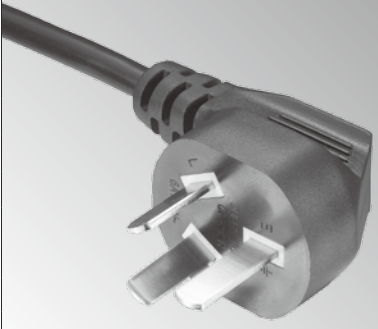
QP-015

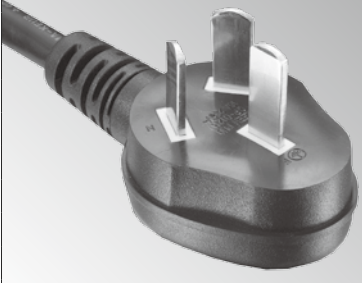
>> China (CCC) type

Style	Type No.	Standard	Available with Cords		Approvals
	QP-011 (6A/10A)	GB1002 GB2099.1	H03VVH2-F	2X 0.75mm ²	6/10A 250V 
			H05VVH2-F	2X 0.75mm ²	
			H03VV-F	2X 0.75mm ²	
			H05VV-F	2X 0.75mm ²	
			H05VV-F	2X 1.00mm ²	
			H05RR-F	2X 0.75mm ²	
			H05RR-F	2X 1.00mm ²	
			H05RN-F	2X 0.75mm ²	
			H05RN-F	2X 1.00mm ²	
	QP-012 (6A/10A)	GB1002 GB2099.1	H03VV-F	3G 0.75mm ²	6/10A 250V 
			H05VV-F	3G 0.75mm ²	
			H05VV-F	3G 1.00mm ²	
			H05RR-F	3G 0.75mm ²	
			H05RR-F	3G 1.00mm ²	
			H05RN-F	3G 0.75mm ²	
			H05RN-F	3G 1.00mm ²	
	QP-012R (6A/10A)	GB1002 GB2099.1	H03VV-F	3G 0.75mm ²	6/10A 250V 
			H05VV-F	3G 0.75mm ²	
			H05VV-F	3G 1.00mm ²	
			H05RR-F	3G 0.75mm ²	
			H05RR-F	3G 1.00mm ²	
			H05RN-F	3G 0.75mm ²	
			H05RN-F	3G 1.00mm ²	
	QP-012R (16A)	GB1002 GB2099.1	H05VV-F	3G 1.50mm ²	16A 250V 
			H05RR-F	3G 1.50mm ²	

QP-011
(6A/10A)

QP-012
(6A/10A)

QP-012R
(6A/10A)

QP-012R
(16A)

>> Japan (PSE) type

Standards	Approval
Electrical Appliance And Material Control Law.	

• Construction

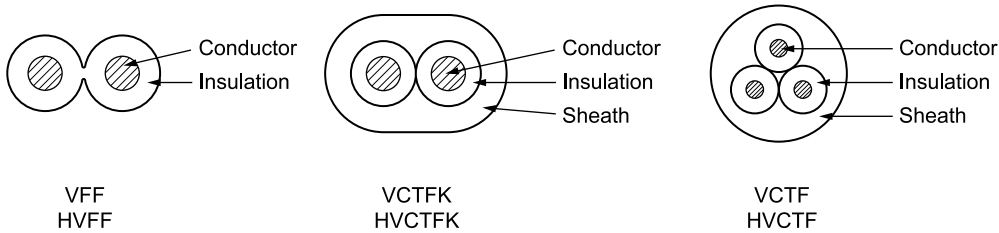

• Dimensions

Types	Conductor		Core	Insulation Thickness mm	Sheath Thickness mm	Overall Diameter mm	Max(at 20°C) Conductor Resistance ohm/km	Rating		
	mm ²	No./mm						Voltage V	Temp. °C	Current A
(H)VFF (EM-CFF)	0.75	30/0.18	2	0.80	-	2.70X5.40	24.40	300	60/75(H)	7
	1.25	50/0.18			-	3.10X6.20	14.70	300	60/75(H)	12
	2.00	37/0.26			-	3.40X6.80	9.50	300	60/75(H)	15
(H)VCTF (OCTF/F)	0.75	30/0.18	2	0.60	1.00	6.60	25.10	300	60/75(H)	7
	1.25	50/0.18				7.40	15.10	300	60/75(H)	12
	2.00	37/0.26				8.00	9.79	300	60/75(H)	15
	0.75	30/0.18	3			7.00	25.10	300	60/75(H)	7
	1.25	50/0.18				7.80	15.10	300	60/75(H)	12
	2.00	37/0.26				8.50	9.79	300	60/75(H)	15
(H)VCTFK (OCTFK/F)	0.75	30/0.18	2	0.60	1.00	4.30X6.60	24.40	300	60/75(H)	7
	1.25	50/0.18				4.70X7.40	14.70	300	60/75(H)	12
	2.00	37/0.26				5.00X8.00	9.50	300	60/75(H)	15
(H)VCT (OCT/F)	0.75	30/0.18	2	0.80	1.80	8.80	24.40	600	60/75(H)	7
	1.25	50/0.18				9.80	14.70	600	60/75(H)	12
	2.00	37/0.26				10.50	9.50	600	60/75(H)	15
	0.75	30/0.18	3	0.80	1.80	9.20	24.40	600	60/75(H)	7
	1.25	50/0.18				9.80	14.70	600	60/75(H)	12
	2.00	37/0.26				10.80	9.50	600	60/75(H)	15







(H)VFF

(H)VCTF

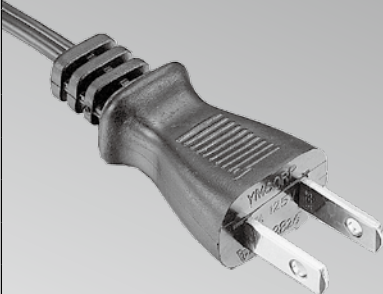
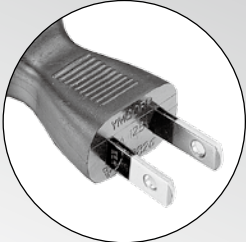

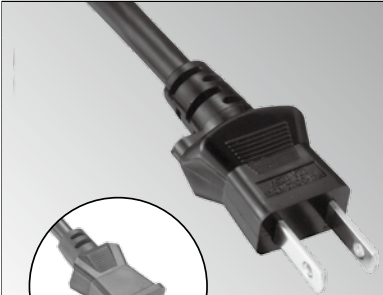

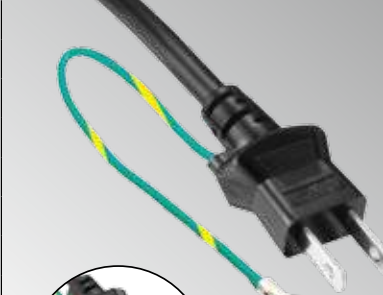

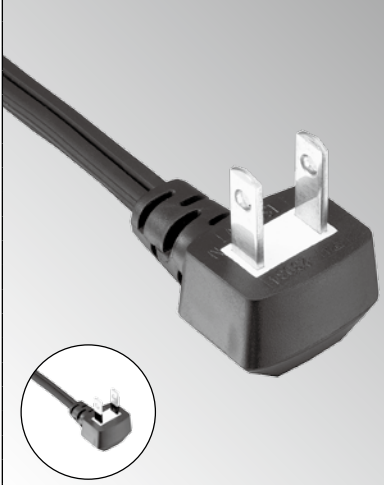

(H)VCTFK

(H)VCT

>> Japan (PSE) type

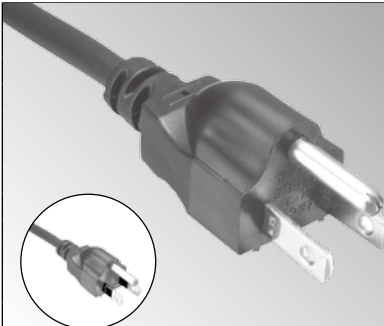
Style	Type No.	Standard	Available with Cords		Approvals	
 	QP-030	Electrical Appliance and Material Control Law Jis 8303	(H)VFF	2X 0.75mm ²	7A 125V	
	QP-030-1 (Insulated Pin)		(H)VCT	2X 0.75mm ²	7A 125V	
	(H)VCTF		2X 0.75mm ²	7A 125V		
	(H)VCTFK		2X 0.75mm ²	7A 125V		
	2PNCT		2X 0.75mm ²	7A 125V		
	EM-CFF		2X 0.75mm ²	7A 125V		
	OOCT/F		2X 0.75mm ²	7A 125V		
	OOCTF/F		2X 0.75mm ²	7A 125V		
	OOCTFK/F		2X 0.75mm ²	7A 125V		
	(H)VFF		2X 1.25/2.00mm ²	12/15A 125V		
	(H)VCT		2X 1.25/2.00mm ²	12/15A 125V		
	(H)VCTF		2X 0.25/2.00mm ²	12/15A 125V		
	(H)VCTFK		2X 0.25/2.00mm ²	12/15A 125V		
	NNFF		2X 1.25/2.00mm ²	12/15A 125V		
	HHFF		2X 1.25/2.00mm ²	12/15A 125V		
	2PNCT		2X 1.25/2.00mm ²	12/15A 125V		
	EM-CFF		2X 1.25/2.00mm ²	12/15A 125V		
OOCT/F	2X 1.25/2.00mm ²	12/15A 125V				
OOCTF/F	2X 1.25/2.00mm ²	12/15A 125V				
OOCTFK/F	2X 1.25/2.00mm ²	12/15A 125V				
 	QP-041-A	Electrical Appliance and Material Control Law Jis 8303	(H)VFF	2X 0.75/1.25/2.00mm ²	7/12/15A 125V	
	QP-041-A-1 (Insulated Pin)		(H)VCT	2X 0.75/1.25/2.00mm ²	7/12/15A 125V	
	(H)VCTF		2X 0.75/1.25/2.00mm ²	7/12/15A 125V		
	(H)VCTFK		2X 0.75/1.25/2.00mm ²	7/12/15A 125V		
	NNFF		2X 0.75/1.25/2.00mm ²	7/12/15A 125V		
	HHFF		2X 0.75/1.25/2.00mm ²	7/12/15A 125V		
	2PNCT		2X 0.75/1.25/2.00mm ²	7/12/15A 125V		
	EM-CFF		2X 0.75/1.25/2.00mm ²	7/12/15A 125V		
	OOCT/F		2X 0.75/1.25/2.00mm ²	7/12/15A 125V		
	OOCTF/F		2X 0.75/1.25/2.00mm ²	7/12/15A 125V		
OOCTFK/F	2X 0.75/1.25/2.00mm ²	7/12/15A 125V				
 	QP-041	Electrical Appliance and Material Control Law Jis 8303	(H)VCT	3G 0.75mm ²	7A 125V	
	QP-041-1 (Insulated Pin)		(H)VCT	3G 1.25mm ²	12A 125V	
	(H)VCT		3G 2.00mm ²	15A 125V		
	(H)VCTF		3G 0.75mm ²	7A 125V		
	(H)VCTF		3G 1.25mm ²	12A 125V		
	(H)VCTF		3G 2.00mm ²	15A 125V		
	OOCT/F		3G 0.75mm ²	7A 125V		
	OOCT/F		3G 1.25mm ²	12A 125V		
	OOCT/F		3G 2.00mm ²	15A 125V		
	OOCTF/F		3G 0.75mm ²	7A 125V		
	OOCTF/F		3G 1.25mm ²	12A 125V		
	OOCTF/F		3G 2.00mm ²	15A 125V		

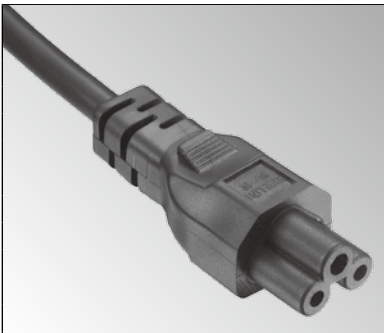
>> Japan (PSE) type

Style	Type No.	Standard	Available with Cords			Approvals	
	QP-042 QP-042-1 (Insulated Pin)	Electrical Appliance and Material Control Law Jis 8303	(H)VFF	2X	0.75mm ²	7A 125V	
			(H)VFF	2X	1.25mm ²	12A 125V	
			(H)VFF	2X	2.00mm ²	15A 125V	
			(H)VCTF	2X	0.75mm ²	7A 125V	
			(H)VCTF	2X	1.25mm ²	12A 125V	
			(H)VCTF	2X	2.00mm ²	15A 125V	
			(H)VCTFK	2X	0.75mm ²	7A 125V	
			(H)VCTFK	2X	1.25mm ²	12A 125V	
			(H)VCTFK	2X	2.00mm ²	15A 125V	
			NNFF/HHFF	2X	0.75mm ²	7A 125V	
			NNFF/HHFF	2X	1.25mm ²	12A 125V	
			NNFF/HHFF	2X	2.00mm ²	15A 125V	
			EM-CFF	2X	0.75mm ²	7A 125V	
			EM-CFF	2X	1.25mm ²	12A 125V	
			EM-CFF	2X	2.00mm ²	15A 125V	
			OOCTF/F	2X	0.75mm ²	7A 125V	
			OOCTF/F	2X	1.25mm ²	12A 125V	
OOCTF/F	2X	2.00mm ²	15A 125V				
OOCTFK/F	2X	0.75mm ²	7A 125V				
OOCTFK/F	2X	1.25mm ²	12A 125V				
OOCTFK/F	2X	2.00mm ²	15A 125V				
	QP-043 QP-043-1 (Insulated Pin)	Electrical Appliance and Material Control Law Jis 8303	(H)VFF	2X	0.75mm ²	7A 125V	
			(H)VFF	2X	1.25mm ²	12A 125V	
			(H)VFF	2X	2.00mm ²	15A 125V	
			(H)VCTF	2X	0.75mm ²	7A 125V	
			(H)VCTF	2X	1.25mm ²	12A 125V	
			(H)VCTF	2X	2.00mm ²	15A 125V	
			(H)VCTFK	2X	0.75mm ²	7A 125V	
			(H)VCTFK	2X	1.25mm ²	12A 125V	
			(H)VCTFK	2X	2.00mm ²	15A 125V	
			EM-CFF	2X	0.75mm ²	7A 125V	
			EM-CFF	2X	1.25mm ²	12A 125V	
			EM-CFF	2X	2.00mm ²	15A 125V	
			OOCTF/F	2X	0.75mm ²	7A 125V	
			OOCTF/F	2X	1.25mm ²	12A 125V	
			OOCTF/F	2X	2.00mm ²	15A 125V	
			OOCTFK/F	2X	0.75mm ²	7A 125V	
			OOCTFK/F	2X	1.25mm ²	12A 125V	
OOCTFK/F	2X	2.00mm ²	15A 125V				
	QP-005 QP-005-1 (Insulated Pin)	Electrical Appliance and Material Control Law Jis 8303	(H)VCT	3G	0.75mm ²	7A 125V	
			(H)VCT	3G	1.25mm ²	12A 125V	
			(H)VCT	3G	2.00mm ²	15A 125V	
			(H)VCTF	3G	0.75mm ²	7A 125V	
			(H)VCTF	3G	1.25mm ²	12A 125V	
			(H)VCTF	3G	2.00mm ²	15A 125V	
			OOCT/F	3G	0.75mm ²	7A 125V	
			OOCT/F	3G	1.25mm ²	12A 125V	
			OOCT/F	3G	2.00mm ²	15A 125V	
			OOCTF/F	3G	0.75mm ²	7A 125V	
			OOCTF/F	3G	1.25mm ²	12A 125V	
			OOCTF/F	3G	2.00mm ²	15A 125V	
	QP-038	Electrical Appliance and Material Control Law Jis 8303	(H)VCT	3G	0.75mm ²	7A 125V	







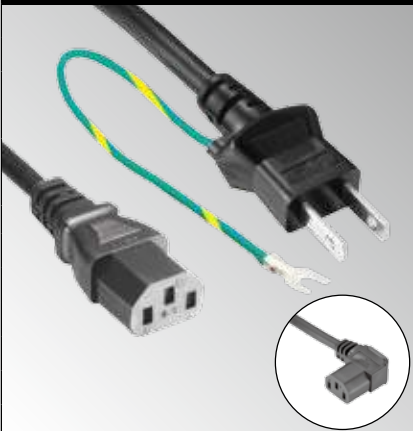

QP-042
QP-042-1
Insulated
Pin

QP-043
QP-043-1
Insulated
Pin

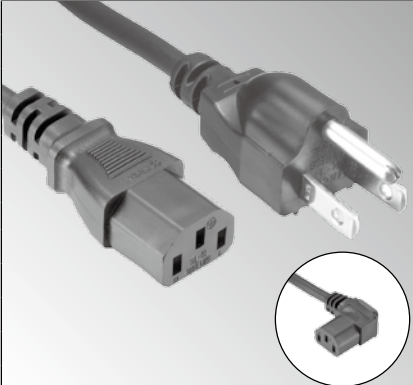



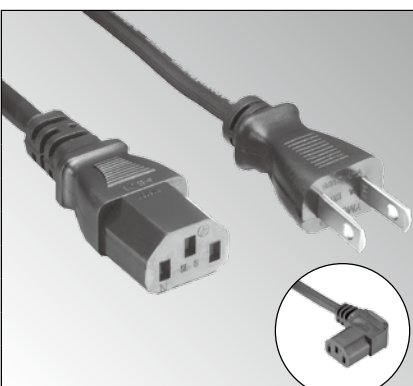

QP-005
QP-005-1
Insulated
Pin

QP-038

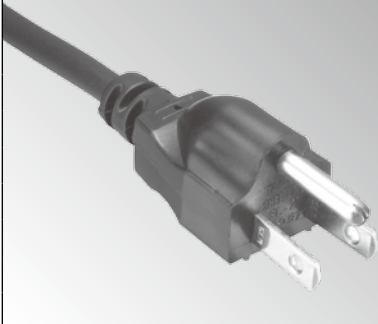
>> Japan (PSE) type

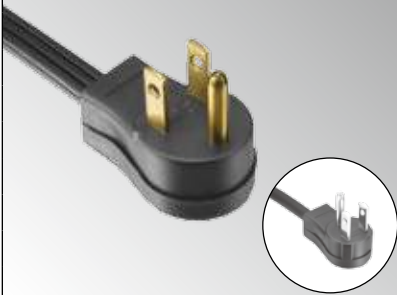
Style	Type No.	Standard	Available with Cords		Approvals
	PLUG: QP-041 Connector: QP-007 QP-018	Electrical Appliance and Material Control Law Jis 8303	(H)VCTF 3G 0.75mm ²	7A 125V	
			(H)VCTF 3G 1.25mm ²	12A 125V	
			(H)VCTF 3G 2.00mm ²	15A 125V	
			OOCTF/F 3G 0.75mm ²	7A 125V	
			OOCTF/F 3G 1.25mm ²	12A 125V	
			OOCTF/F 3G 2.00mm ²	15A 125V	
	PLUG: QP-005 Connector: QP-007 QP-018	Electrical Appliance and Material Control Law Jis 8303	(H)VCTF 3G 0.75mm ²	7A 125V	
			(H)VCTF 3G 1.25mm ²	12A 125V	
			(H)VCTF 3G 2.00mm ²	15A 125V	
			OOCTF/F 3G 0.75mm ²	7A 125V	
			OOCTF/F 3G 1.25mm ²	12A 125V	
			OOCTF/F 3G 2.00mm ²	15A 125V	
	PLUG: QP-030 Connector: QP-045	Electrical Appliance and Material Control Law Jis 8303	(H)VFF 2X 0.75mm ²	7A 125V	
			(H)VCTFK 2X 0.75mm ²	7A 125V	
			EM-CFF 2X 0.75mm ²	7A 125V	
			OOCTFK/F 2X 0.75mm ²	7A 125V	
			(H)VFF 2 X 0.75 mm ²	7A 125V	
	PLUG: QP-030 Connector: QP-007 QP-018	Electrical Appliance and Material Control Law Jis 8303	(H)VCTF 2X 0.75mm ²	7A 125V	
			(H)VCTF 2X 1.25mm ²	12A 125V	
			(H)VCTF 2X 2.00mm ²	15A 125V	
			(H)VCTFK 2X 0.75mm ²	7A 125V	
			(H)VCTFK 2X 1.25mm ²	12A 125V	
			(H)VCTFK 2X 2.00mm ²	15A 125V	
			OOCTF/F 2X 0.75mm ²	7A 125V	
			OOCTF/F 2X 1.25mm ²	12A 125V	
			OOCTF/F 2X 2.00mm ²	15A 125V	
			OOCTFK/F 2X 0.75mm ²	7A 125V	
			OOCTFK/F 2X 1.25mm ²	12A 125V	
			OOCTFK/F 2X 2.00mm ²	15A 125V	

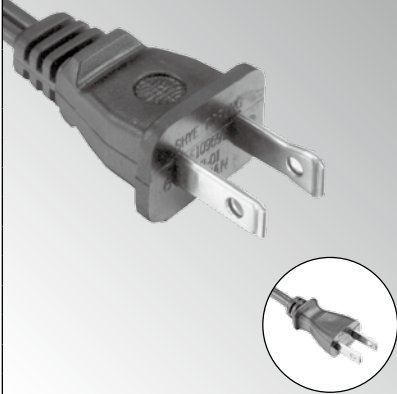
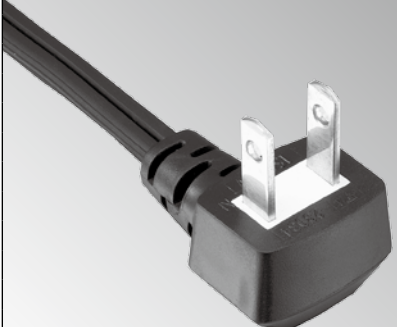
>> Taiwan (BSMI) type

Style	Type No.	Standard	Available with Cords			Approvals	
	QP-02 Series of type: SP-05	CNS10917	H03VV-F	3G	0.75mm ²	7A 125V	
		CNS690	H05RR-F	3G	0.75mm ²	7A 125V	
		CNS10917-2	H05RN-F	3G	0.75mm ²	7A 125V	
		H05VV-F	3G	0.75/1.00/1.50mm ²	7A/10A/11A/15A 125V		
		H07RN-F	3G	1.00/1.50mm ²	10A/11A/15A 125V		
		(H)VCTF	3G	0.75/1.25/2.00mm ²	7A/10A/11A/15A 125V		
		PNCTF	3G	0.75/1.25/2.00mm ²	7A/10A/11A/15A 125V		
		RNCTF	3G	0.75/1.25/2.00mm ²	7A/10A/11A/15A 125V		
		VCT	3G	0.75/1.25/2.00mm ²	7A/10A/11A/15A 125V		
	QP-02-1		H05VV-F	3G	2.50mm ²	15A 125V	
		H07RN-F	3G	2.50mm ²	15A 125V		
	QP-05 Series of type: QP-05-1	CNS10917	H03VV-F	3G	0.75mm ²	7A 125V	
		CNS690	H05RR-F	3G	0.75mm ²	7A 125V	
		CNS10917-2	H05RN-F	3G	0.75mm ²	7A 125V	
		H05VV-F	3G	0.75/1.00/1.50mm ²	7A/10A/11A/15A 125V		
		H07RN-F	3G	1.00/1.50mm ²	10A/11A/15A 125V		
		(H)VCTF	3G	0.75/1.25/2.00mm ²	7A/10A/11A/15A 125V		
		PNCTF	3G	0.75/1.25/2.00mm ²	7A/10A/11A/15A 125V		
		RNCTF	3G	0.75/1.25/2.00mm ²	7A/10A/11A/15A 125V		
		VCT	3G	0.75/1.25/2.00mm ²	7A/10A/11A/15A 125V		
		QP-01 Series of type: QP-01P QP-03 QP-03P QP-030 QP-030P SP-30 SP-30P	CNS10917	H03VV-F	2X	0.75mm ²	
CNS690			H03VVH2-F	2X	0.75mm ²	7A 125V	
CNS10917-2			H05RR-F	2X	0.75mm ²	7A 125V	
H05RN-F			2X	0.75mm ²	7A 125V		
H07RN-F			2X	1.00/1.50mm ²	7A/11A/15A 125V		
H05VV-F			2X	0.75/1.00/1.50mm ²	7A/11A/15A 125V		
H05VVH2-F			2X	0.75/1.00mm ²	7A 125V		
(H)VFF			2X	0.75/1.25/2.00mm ²	7A/11A/15A 125V		
(H)VCTF			2X	0.75/1.25/2.00mm ²	7A/11A/15A 125V		
(H)VCTFK			2X	0.75/1.25/2.00mm ²	7A/11A/15A 125V		
NNFF			2X	0.75/1.25/2.00mm ²	7A/11A/15A 125V		
VCT			2X	0.75/1.25/2.00mm ²	7A/11A/15A 125V		
PNCTF			2X	0.75/1.25/2.00mm ²	7A/11A/15A 125V		
PNCTFK			2X	0.75/1.25/2.00mm ²	7A/11A/15A 125V		
RNCTF			2X	0.75/1.25/2.00mm ²	7A/11A/15A 125V		
RNCTFK	2X	0.75/1.25/2.00mm ²	7A/11A/15A 125V				
	QP-042 Series of type: QP-042P QP-099 QP-099P SP-31 SP-31P	CNS10917	H03VV-F	2X	0.75mm ²	7A 125V	
		CNS690	H03VVH2-F	2X	0.75mm ²	7A 125V	
		CNS10917-2	H05RR-F	2X	0.75mm ²	7A 125V	
		H05RN-F	2X	0.75mm ²	7A 125V		
		H07RN-F	2X	1.00/1.50mm ²	7A/11A/15A 125V		
		H05VV-F	2X	0.75/1.00/1.50mm ²	7A/11A/15A 125V		
		H05VVH2-F	2X	0.75/1.0mm ²	7A 125V		
		(H)VFF	2X	0.75/1.25/2.0mm ²	7A/11A/15A 125V		
		(H)VCTF	2X	0.75/1.25/2.0mm ²	7A/11A/15A 125V		
		(H)VCTFK	2X	0.75/1.25/2.0mm ²	7A/11A/15A 125V		
		NNFF	2X	0.75/1.25/2.0mm ²	7A/11A/15A 125V		
		VCT	2X	0.75/1.25/2.0mm ²	7A/11A/15A 125V		
		PNCTF	2X	0.75/1.25/2.0mm ²	7A/11A/15A 125V		
		PNCTFK	2X	0.75/1.25/2.0mm ²	7A/11A/15A 125V		
		RNCTF	2X	0.75/1.25/2.0mm ²	7A/11A/15A 125V		
RNCTFK	2X	0.75/1.25/2.0mm ²	7A/11A/15A 125V				

QP-02

QP-05

QP-01

QP-042

>> Taiwan (BSMI) type

Style	Type No.	Standard	Available with Cords		Approvals	
	QP-018-1R	CNS10917-3	H03VV-F	3G 0.75mm ²	7A 125V	
	Series of type:	CNS10917	H05RR-F	3G 0.75mm ²	7A 125V	
	QP-018R	IEC60320-1	H05RN-F	3G 0.75mm ²	7A 125V	
	QP-018L	CNS690	H07RN-F	3G 1.00/1.50mm ²	10A/15A 125V	
	Match with plug:		H05VV-F	3G 0.75/1.00/1.50mm ²	7A/10A/15A 125V	
	QP-02		(H)VCTF	3G 0.75/1.25/2.00mm ²	7A/10A/15A 125V	
	QP-05		PNCTF	3G 0.75/1.25/2.00mm ²	7A/10A/15A 125V	
	QP-05-1		RNCTF	3G 0.75/1.25/2.00mm ²	7A/10A/15A 125V	
	SP-05		VCT	3G 0.75/1.25/2.00mm ²	7A/10A/15A 125V	

	QP-007	CNS10917-3	H03VV-F	3G 0.75mm ²	7A 125V	
	Series of type:	CNS10917	H05RR-F	3G 0.75mm ²	7A 125V	
	QC-01	IEC60320-1	H05RN-F	3G 0.75mm ²	7A 125V	
	Match with plug:	CNS690	H07RN-F	3G 1.00/1.50mm ²	10A/15A 125V	
	QP-02		H05VV-F	3G 0.75/1.00/1.50mm ²	7A/10A/15A 125V	
	QP-05		(H)VCTF	3G 0.75/1.25/2.00mm ²	7A/10A/15A 125V	
	QP-05-1		PNCTF	3G 0.75/1.25/2.00mm ²	7A/10A/15A 125V	
	SP-05		RNCTF	3G 0.75/1.25/2.00mm ²	7A/10A/15A 125V	
			VCT	3G 0.75/1.25/2.00mm ²	7A/10A/15A 125V	

	QP-045	CNS10917-3	H03VVH2-F	2X 0.75mm ²	7A 125V	
	Series of type:	IEC60320-1	(H)VFF	2X 0.75mm ²	7A 125V	
	SP-09	CNS10917	(H)VCTFK	2X 0.75mm ²	7A 125V	
	Match with plug:		PNCTFK	2X 0.75mm ²	7A 125V	
	QP-01/QP-01P		RNCTFK	2X 0.75mm ²	7A 125V	
	QP-03/QP-03P					
	QP-030/QP-030P					
	QP-042/QP-042P					
	QP-099/QP-099P					
	SP-30/SP-30P					
SP-31/SP-31P						

Style	Type No.	Standard	Available with Cords		Approvals	
	QP-038	K60320-1	H03VV-F	3G 0.75mm ²	6A 125V	
			H05VV-F	3G 0.75mm ²	6A 125V	
			H05RN-F	3G 0.75mm ²	6A 125V	
			H05RR-F	3G 0.75mm ²	7A 125V	
			H07RN-F	3G 1.0mm ²	7A 125V	
			VCT	3x 0.75mm ²	7A 125V	
			(H)VCTF	3x 0.75mm ²	7A 125V	
			PNCTF	3x 0.75mm ²	7A 125V	

>> American (UL) type

Standards	Approval
UL 62: Flexible Cord and Fixture Wire C22.2 No. 49: Flexible Cord and Cables	C-UL File No.: E183417

• Construction

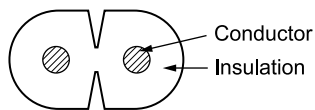

SPT-1
SPT-2

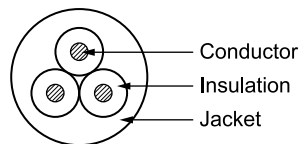



SVT
SJT



• Dimensions

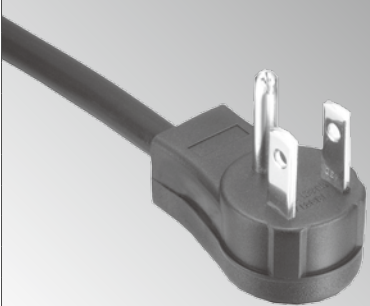

Types	Conductor			Core	Insulation Thickness mm	Jacket Thickness mm	Overall Diameter mm	Rating			
	AWG	mm ²	No./mm					Voltage V	Temp. °C	Current A	
SPT-1(W)	18	0.82	41/0.16	2	-	0.76	2.70X5.40	300	60~105	10	
	18	0.82	41/0.16	3*	-		2.70X7.70	300	60~105	10	
NISPT-1	18	0.82	41/0.16	2	0.38	0.38	2.80X5.40	300	60~105	10	
SPT-2(W)	18	0.82	41/0.16	2	-	1.14	3.40X6.90	300	60~105	10	
	16	1.31	26/0.25		-		3.80X7.50	300	60~105	13	
	18	0.82	41/0.16	3*	0.35		3.50X8.60	300	60~105	10	
	16	1.31	26/0.25		0.35		3.60X9.60	300	60~105	13	
NISPT-2	18	0.82	41/0.16	2	0.76	0.38	4.05X7.50	300	60~105	10	
SPT-3	18	0.82	41/0.16	2	-	1.52	4.20X8.40	300	60~105	10	
	16	1.31	26/0.25		-		4.50X9.00	300	60~105	13	
	18	0.82	41/0.16	3	0.38		4.40X10.80	300	60~105	10	
	16	1.31	26/0.25		0.38		4.80X11.80	300	60~105	13	
XT(W)	20	0.52	21/0.18	2	-	0.76	2.50X5.00	300	60~105	10	
	18	0.82	41/0.16		-		2.80X5.60	300	60~105	10	
SVT	18	0.82	41/0.16	2	0.38		6.00	300	60~105	10	
	18	0.82	41/0.16	3			6.30	300	60~105	10	
ST/STW/ STO/STOW	18	0.82	41/0.16	2	0.76	1.52	8.50	600	60~105	10	
	16	1.31	26/0.25				9.10	600	60~105	13	
	14	2.08	41/0.25		1.14		2.03	12.50	600	60~105	15
	12	3.31	65/0.25				2.41	13.40	600	60~105	20
	18	0.82	41/0.16	3	0.76	1.52	9.00	600	60~105	10	
	16	1.31	26/0.25				9.50	600	60~105	13	
	14	2.08	41/0.25		1.14		2.03	13.00	600	60~105	15
	12	3.31	65/0.25				2.41	14.10	600	60~105	20
SJT/SJTW/ SJTO/SJTOW	18	0.82	41/0.16	2	0.76	0.76	7.40	300	60~105	10	
	16	1.31	26/0.25				8.10	300	60~105	13	
	14	2.08	41/0.25				8.70	300	60~105	15	
	12	3.31	65/0.25				9.90	300	60~105	20	
	18	0.82	41/0.16	3			7.80	300	60~105	10	
	16	1.31	26/0.25				8.50	300	60~105	13	
	14	2.08	41/0.25				9.30	300	60~105	15	
	12	3.31	65/0.25				10.80	300	60~105	20	
SJO/SJOW/ SJO/SJOOW	18	0.82	41/0.16	2	0.76	0.76	7.40	300	60~105	10	
	16	1.31	26/0.25				8.10	300	60~105	13	
	14	2.08	41/0.25				8.70	300	60~105	15	
	12	3.31	65/0.25				9.90	300	60~105	20	
	18	0.82	41/0.16	3			7.80	300	60~105	10	
	16	1.31	26/0.25				8.50	300	60~105	13	
	14	2.08	41/0.25				9.30	300	60~105	15	
	12	3.31	65/0.25				10.80	300	60~105	20	
HPN	18	0.82	41/0.16	2	-	1.14	3.50X6.90	300	90~105	10	
	16	1.31	26/0.25		-		3.80X7.60	300	90~105	13	
	18	0.82	41/0.16	3	0.38		3.80X9.00	300	90~105	10	
	16	1.31	26/0.25				4.00X10.00	300	90~105	13	



* 無 SPT-1W 18/3C / No SPT-1W 18/3C Cable、無 SPT-2W 18/3C / No SPT-2W 18/3C Cable

>> American (UL) type

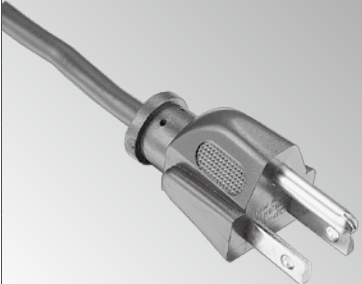
Style	Type No.	Standard	Available with Cords			Approvals
	PLUG: QP-033-D (5-15P)	UL-817 (QP-05)	Shielded & Unshielded Cord			
			SVT	18AWG ×3C	10A 125V	
			SPT-2/SPT-2W	18AWG ×3C	10A 125V	
			SPT-3	18AWG ×3C	10A 125V	
			SJT/SJTW	18AWG ×3C	10A 125V	
			SPT-2/SPT-2W	16AWG ×3C	13A 125V	
			SPT-3	16AWG ×3C	13A 125V	
			SJT/SJTW	16AWG ×3C	13A 125V	
			SPT-3	14AWG ×3C	15A 125V	
			SJT/SJTW	14AWG ×3C	15A 125V	

	QP-033-U (5-15P)	UL-817 (QP-05)	Shielded & Unshielded Cord			
			SVT	18AWG ×3C	10A 125V	
			SPT-2/SPT-2W	18AWG ×3C	10A 125V	
			SPT-3	18AWG ×3C	10A 125V	
			SJT/SJTW	18AWG ×3C	10A 125V	
			SPT-2/SPT-2W	16AWG ×3C	13A 125V	
			SPT-3	16AWG ×3C	13A 125V	
			SJT/SJTW	16AWG ×3C	13A 125V	
			SPT-3	14AWG ×3C	15A 125V	
			SJT/SJTW	14AWG ×3C	15A 125V	

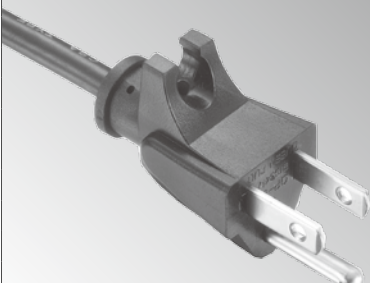
	PLUG: QP-005 (5-15P)	UL-817 (QP-02)	Shielded & Unshielded Cord			
			SPT-1/SPT-2/SPT-3	18AWG ×3C	10A 125V	
			HPN	18AWG ×3C	10A 125V	
			SVT/SJT/SJTW	18AWG ×3C	10A 125V	
			SJ/SJO/SJOW	18AWG ×3C	10A 125V	
			SPT-2/SPT-3	16AWG ×3C	13A 125V	
			HPN	16AWG ×3C	13A 125V	
			SVT/SJT/SJTW	16AWG ×3C	13A 125V	
			SJ/SJO/SJOW	16AWG ×3C	13A 125V	
			SPT-3	14AWG ×3C	15A 125V	
			HPN	14AWG ×3C	15A 125V	
			SJT/SJTW	14AWG ×3C	15A 125V	
			SJ/SJO/SJOW	14AWG ×3C	15A 125V	

	PLUG: QP-005A (5-15P)	UL-817 (QP-02A)	Shielded & Unshielded Cord			
			SPT-1/SPT-2/SPT-3	18AWG ×3C	10A 125V	
			HPN	18AWG ×3C	10A 125V	
			SVT/SJT/SJTW	18AWG ×3C	10A 125V	
			SJ/SJO/SJOW	18AWG ×3C	10A 125V	
			SPT-2/SPT-3	16AWG ×3C	13A 125V	
			HPN	16AWG ×3C	13A 125V	
			SVT/SJT/SJTW	16AWG ×3C	13A 125V	
			SJ/SJO/SJOW	16AWG ×3C	13A 125V	
			SPT-3	14AWG ×3C	15A 125V	
			HPN	14AWG ×3C	15A 125V	
			SJT/SJTW	14AWG ×3C	15A 125V	
			SJ/SJO/SJOW	14AWG ×3C	15A 125V	



QP-033-D



QP-033-U

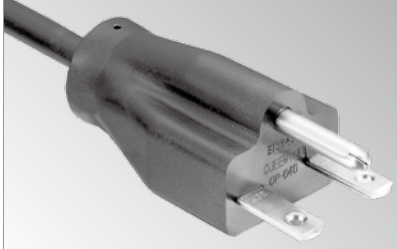

QP-005

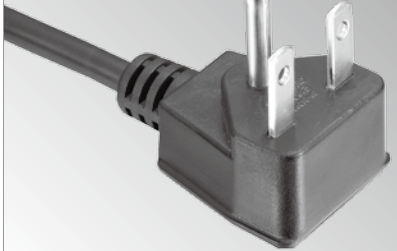

QP-005A

>> American (UL) type

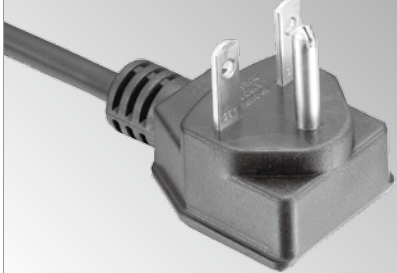

Style	Type No.	Standard	Available with Cords			Approvals	
	QP-040 (6-15P)	UL-817	Shielded & Unshielded Cord			 C-UL	
			SJT/SJTW	18AWG	×3C		10A 250V
			SJTOW	18AWG	×3C		10A 250V
			SJ/SJW	18AWG	×3C		10A 250V
			SJO/SJOW	18AWG	×3C		10A 250V
			SJT/SJTW	16AWG	×3C		13A 250V
			SJTOW	16AWG	×3C		13A 250V
			SJ/SJW	16AWG	×3C		13A 250V
			SJO/SJOW	16AWG	×3C		13A 250V
			SJT/SJTW	12/14AWG	×3C		15A 250V
			SJTOW	12/14AWG	×3C		15A 250V
			SJ/SJW	12/14AWG	×3C		15A 250V
			SJO/SJOW	12/14AWG	×3C		15A 250V

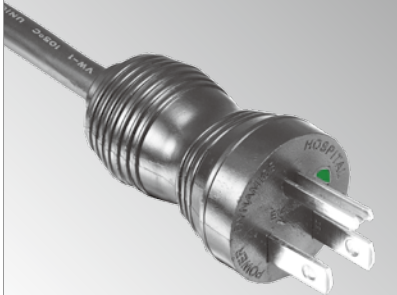
Style	Type No.	Standard	Available with Cords			Approvals	
	QP-040RD (6-15P)	UL-817	Shielded & Unshielded Cord			 C-UL	
			SJT/SJTW	18AWG	×3C		10A 250V
			SJTOW	18AWG	×3C		10A 250V
			SJ/SJW	18AWG	×3C		10A 250V
			SJO/SJOW	18AWG	×3C		10A 250V
			SJT/SJTW	16AWG	×3C		13A 250V
			SJTOW	16AWG	×3C		13A 250V
			SJ/SJW	16AWG	×3C		13A 250V
			SJO/SJOW	16AWG	×3C		13A 250V
			SJT/SJTW	12/14AWG×3C			15A 250V
			SJTOW	12/14AWG×3C			15A 250V
			SJ/SJW	12/14AWG×3C			15A 250V
			SJO/SJOW	12/14AWG×3C			15A 250V

Style	Type No.	Standard	Available with Cords			Approvals	
	QP-040RU (6-15P)	UL-817	Shielded & Unshielded Cord			 C-UL	
			SJT/SJTW	18AWG	×3C		10A 250V
			SJTOW	18AWG	×3C		10A 250V
			SJ/SJW	18AWG	×3C		10A 250V
			SJO/SJOW	18AWG	×3C		10A 250V
			SJT/SJTW	16AWG	×3C		13A 250V
			SJTOW	16AWG	×3C		13A 250V
			SJ/SJW	16AWG	×3C		13A 250V
			SJO/SJOW	16AWG	×3C		13A 250V
			SJT/SJTW	12/14AWG×3C			15A 250V
			SJTOW	12/14AWG×3C			15A 250V
			SJ/SJW	12/14AWG×3C			15A 250V
			SJO/SJOW	12/14AWG×3C			15A 250V

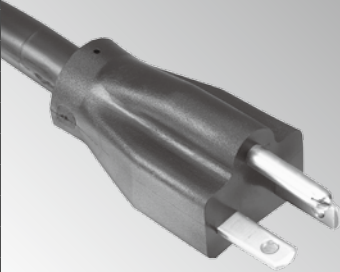

Style	Type No.	Standard	Available with Cords			Approvals	
	QP-049 (5-15P) Hospital Grade	UL-817	Shielded & Unshielded Cord			 C-UL	
			SVT	18AWG	×3C		10A 125V
			SJT/SJTW	18AWG	×3C		10A 125V
			SJT/SJTW	16AWG	×3C		13A 125V
			SJT/SJTW	14AWG	×3C		15A 125V

>> American (UL) type

Style	Type No.	Standard	Available with Cords			Approvals
	QP-055 (5-20P)	UL-817	Shielded & Unshielded Cord			
			SJT/SJTW	18AWG ×3C	10A125V	
			SJTOW	18AWG ×3C	10A125V	
			SJ/SJW	18AWG ×3C	10A125V	
			SJO/SJOW	18AWG ×3C	10A125V	
			SJT/SJTW	16AWG ×3C	13A125V	
			SJTOW	16AWG ×3C	13A125V	
			SJ/SJW	16AWG ×3C	13A125V	
			SJO/SJOW	16AWG ×3C	13A125V	
			SJT/SJTW	12/14AWG×3C	20/15A125V	
			SJTOW	12/14AWG×3C	20/15A125V	
			SJ/SJW	12/14AWG×3C	20/15A125V	
			SJO/SJOW	12/14AWG×3C	20/15A125V	

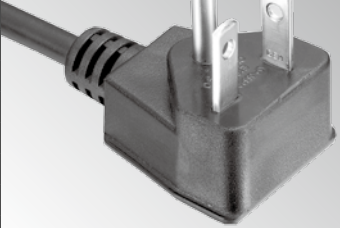

QP-055



QP-055-RD

	QP-055-RD (5-20P)	UL-817	Shielded & Unshielded Cord			
			SJT/SJTW	18AWG ×3C	10A125V	
			SJTOW	18AWG ×3C	10A125V	
			SJ/SJW	18AWG ×3C	10A125V	
			SJO/SJOW	18AWG ×3C	10A125V	
			SJT/SJTW	16AWG ×3C	13A125V	
			SJTOW	16AWG ×3C	13A125V	
			SJ/SJW	16AWG ×3C	13A125V	
			SJO/SJOW	16AWG ×3C	13A125V	
			SJT/SJTW	12/14AWG×3C	20/15A125V	
			SJTOW	12/14AWG×3C	20/15A125V	
			SJ/SJW	12/14AWG×3C	20/15A125V	
			SJO/SJOW	12/14AWG×3C	20/15A125V	

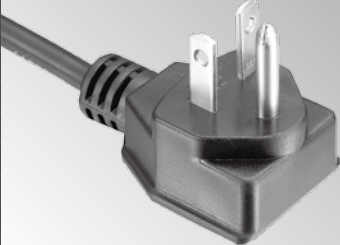

QP-055-RU



QP-015

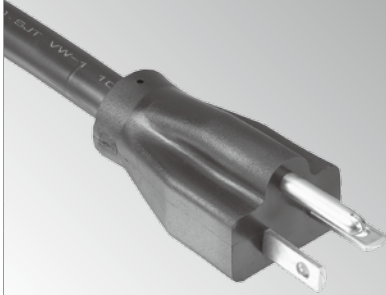

	QP-055-RU (5-20P)	UL-817	Shielded & Unshielded Cord			
			SJT/SJTW	18AWG ×3C	10A125V	
			SJTOW	18AWG ×3C	10A125V	
			SJ/SJW	18AWG ×3C	10A125V	
			SJO/SJOW	18AWG ×3C	10A125V	
			SJT/SJTW	16AWG ×3C	13A125V	
			SJTOW	16AWG ×3C	13A125V	
			SJ/SJW	16AWG ×3C	13A125V	
			SJO/SJOW	16AWG ×3C	13A125V	
			SJT/SJTW	12/14AWG×3C	20/15A125V	
			SJTOW	12/14AWG×3C	20/15A125V	
			SJ/SJW	12/14AWG×3C	20/15A125V	
			SJO/SJOW	12/14AWG×3C	20/15A125V	

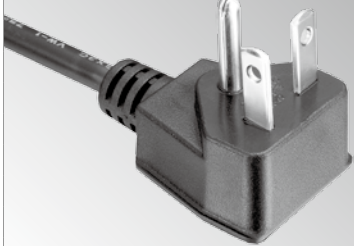

	QP-015	IEC60 320 C14	Shielded & Unshielded Cord			
			SPT-2/SPT-2W	18AWG ×3C	10A125V	
			SPT-3	18AWG ×3C	10A125V	
			SVT	18AWG ×3C	10A125V	
			SJT/SJTW	18AWG ×3C	10A125V	
			SPT-2/SPT-2W	16AWG ×3C	13A125V	
			SPT-3	16AWG ×3C	13A125V	
			SJT/SJTW	16AWG ×3C	13A125V	
			SPT-3	14AWG ×3C	15A125V	
			SJT/SJTW	14AWG ×3C	15A125V	

>> American (UL) type

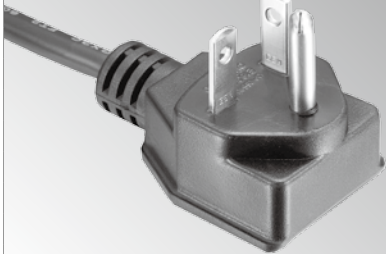

Style	Type No.	Standard	Available with Cords			Approvals
	QP-056 (6-20P)	UL-817	Shielded & Unshielded Cord			
			SJT/SJTW	18AWG ×3C	10A250V	
			SJTOW	18AWG ×3C	10A250V	
			SJ/SJW	18AWG ×3C	10A250V	
			SJO/SJOW	18AWG ×3C	10A250V	
			SJT/SJTW	16AWG ×3C	13A250V	
			SJTOW	16AWG ×3C	13A250V	
			SJ/SJW	16AWG ×3C	13A250V	
			SJO/SJOW	16AWG ×3C	13A250V	
			SJT/SJTW	12/14AWG×3C	20/15A250V	
			SJTOW	12/14AWG×3C	20/15A250V	
			SJ/SJW	12/14AWG×3C	20/15A250V	
			SJO/SJOW	12/14AWG×3C	20/15A250V	



	QP-056-RD (6-20P)	UL-817	Shielded & Unshielded Cord			
			SJT/SJTW	18AWG ×3C	10A250V	
			SJTOW	18AWG ×3C	10A250V	
			SJ/SJW	18AWG ×3C	10A250V	
			SJO/SJOW	18AWG ×3C	10A250V	
			SJT/SJTW	16AWG ×3C	13A250V	
			SJTOW	16AWG ×3C	13A250V	
			SJ/SJW	16AWG ×3C	13A250V	
			SJO/SJOW	16AWG ×3C	13A250V	
			SJT/SJTW	12/14AWG×3C	20/15A250V	
			SJTOW	12/14AWG×3C	20/15A250V	
			SJ/SJW	12/14AWG×3C	20/15A250V	
			SJO/SJOW	12/14AWG×3C	20/15A250V	

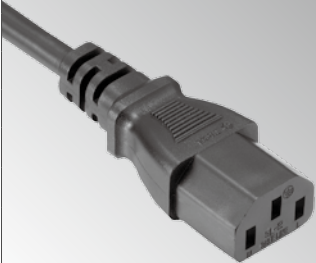

	QP-056-RU (6-20P)	UL-817	Shielded & Unshielded Cord			
			SJT/SJTW	18AWG ×3C	10A250V	
			SJTOW	18AWG ×3C	10A250V	
			SJ/SJW	18AWG ×3C	10A250V	
			SJO/SJOW	18AWG ×3C	10A250V	
			SJT/SJTW	16AWG ×3C	13A250V	
			SJTOW	16AWG ×3C	13A250V	
			SJ/SJW	16AWG ×3C	13A250V	
			SJO/SJOW	16AWG ×3C	13A250V	
			SJT/SJTW	12/14AWG×3C	20/15A250V	
			SJTOW	12/14AWG×3C	20/15A250V	
			SJ/SJW	12/14AWG×3C	20/15A250V	
			SJO/SJOW	12/14AWG×3C	20/15A250V	



	QP-064 (6-15R)	UL-817	Shielded & Unshielded Cord			
			SJT/SJTW	18AWG ×3C	10A250V	
			SJTOW	18AWG ×3C	10A250V	
			SJ/SJO/SJOW	18AWG ×3C	10A250V	
			SJT/SJTW	16AWG ×3C	13A250V	
			SJTOW	16AWG ×3C	13A250V	
			SJ/SJO/SJOW	16AWG ×3C	13A250V	
			SJT/SJTW	14AWG ×3C	15A250V	
			SJTOW	14AWG ×3C	15A250V	
			SJ/SJO/SJOW	14AWG ×3C	15A250V	
			SJT/SJTW	12AWG ×3C	15A250V	
			SJTOW	12AWG ×3C	15A250V	
			SJ/SJO/SJOW	12AWG ×3C	15A250V	

>> American (UL) type

Style	Type No.	Standard	Available with Cords			Approvals
	PLUG: QP-007	UL-817 IEC60 320 C13	Shielded & Unshielded Cord			
			SVT	18AWG ×3C	10A 125V/250V	
			SJT/SJTW	18AWG ×3C	10A 125V/250V	
			SJT/SJTW	16AWG ×3C	13A 125V/250V	
			SJT/SJTW	14AWG ×3C	15A 125V/250V	

Style	Type No.	Standard	Available with Cords			Approvals
	PLUG: QP-007	UL-817 IEC60 320 C13 (QC-01)	Shielded & Unshielded Cord			
			SVT	18AWG ×3C	10A 125V	
			SJT/SJTW	18AWG ×3C	10A 125V	
			SJTO/SJTOW	18AWG ×3C	10A 125V	
			SJ/SJO/SJOW	18AWG ×3C	10A 125V	
			SJT/SJTW	16AWG ×3C	13A 125V	
			SJTO/SJTOW	16AWG ×3C	13A 125V	
			SJ/SJO/SJOW	16AWG ×3C	13A 125V	
			SJT/SJTW	14AWG ×3C	15A 125V	
			SJTO/SJTOW	14AWG ×3C	15A 125V	

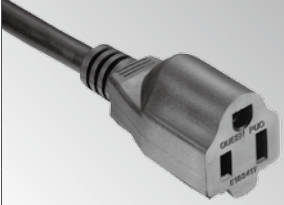
Style	Type No.	Standard	Available with Cords			Approvals
	PLUG: QP-018	UL-817 IEC60 320 C13	Shielded & Unshielded Cord			
			SVT	18AWG ×3C	10A 250V	
			SJT/SJTW	18AWG ×3C	10A 250V	
			SJT/SJTW	16AWG ×3C	13A 250V	
			SJT/SJTW	14AWG ×3C	15A 250V	

Style	Type No.	Standard	Available with Cords			Approvals
	PLUG: QP-016 (5-15R)	UL-498	Shielded & Unshielded Cord			
			SVT	16AWG ×3C	13A 125V	
			SJT	16AWG ×3C	13A 125V	
			SPT-2/SPT-2W	16AWG ×3C	13A 125V	
			SJT/SJTW	14AWG ×3C	15A 125V	



QP-007



QP-007

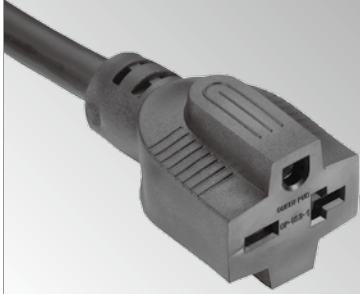

QP-018

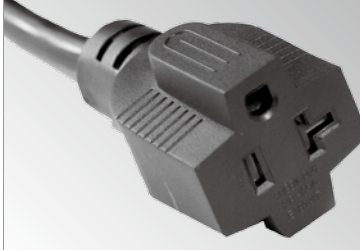

QP-016

>> American (UL) type

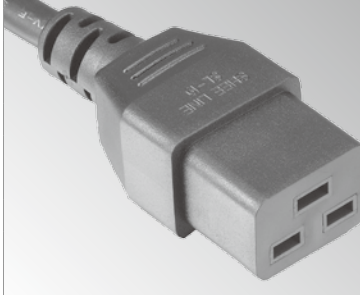
Style	Type No.	Standard	Available with Cords			Approvals
	QP-053 (6-20R)	UL-817	Shielded & Unshielded Cord			
			SJT/SJTW	18AWG ×3C	10A 250V	
			SJTOW	18AWG ×3C	10A 250V	
			SJ/SJO/SJOW	18AWG ×3C	10A 250V	
			SJT/SJTW	16AWG ×3C	13A 250V	
			SJTOW	16AWG ×3C	13A 250V	
			SJ/SJO/SJOW	16AWG ×3C	13A 250V	
			SJT/SJTW	14AWG ×3C	15A 250V	
			SJTOW	14AWG ×3C	15A 250V	
			SJ/SJO/SJOW	14AWG ×3C	15A 250V	
			SJT/SJTW	12AWG ×3C	20A 250V	
			SJTOW	12AWG ×3C	20A 250V	
SJ/SJO/SJOW	12AWG ×3C	20A 250V				

	QP-054 (5-20R)	UL-817	Shielded & Unshielded Cord			
			SJT/SJTW	18AWG ×3C	10A 250V	
			SJTOW	18AWG ×3C	10A 250V	
			SJ/SJO/SJOW	18AWG ×3C	10A 250V	
			SJT/SJTW	16AWG ×3C	13A 250V	
			SJTOW	16AWG ×3C	13A 250V	
			SJ/SJO/SJOW	16AWG ×3C	13A 250V	
			SJT/SJTW	14AWG ×3C	15A 250V	
			SJTOW	14AWG ×3C	15A 250V	
			SJ/SJO/SJOW	14AWG ×3C	15A 250V	
			SJT/SJTW	12AWG ×3C	20A 250V	
			SJTOW	12AWG ×3C	20A 250V	
SJ/SJO/SJOW	12AWG ×3C	20A 250V				



	QP-052 (C-19)	UL-817 IEC 60320 C19	Shielded & Unshielded Cord			
			SJT/SJTW	16AWG ×3C	13A 125V	
			SJO/SJOW	16AWG ×3C	13A 125V	
			SJT/SJTW	14AWG ×3C	15A 125V	
			SJO/SJOW	14AWG ×3C	15A 125V	
			SJT/SJTW	12AWG ×3C	15A 125V	
			SJO/SJOW	12AWG ×3C	15A 125V	

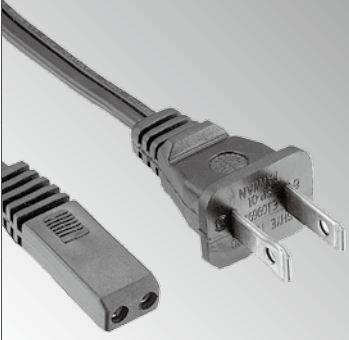

	QP-051 (C-20)	UL-817 IEC 60320 C20	Shielded & Unshielded Cord			
			SJT/SJTW	16AWG ×3C	13A 125V	
			SJO/SJOW	16AWG ×3C	13A 125V	
			SJT/SJTW	14AWG ×3C	15A 125V	
			SJO/SJOW	14AWG ×3C	15A 125V	
			SJT/SJTW	12AWG ×3C	15A 125V	
			SJO	12AWG ×3C	15A 125V	

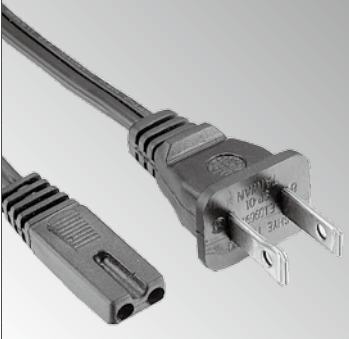
>> American (UL) type

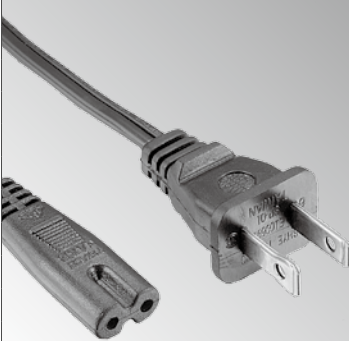
Style	Type No.	Standard	Available with Cords			Approvals
	PLUG:	UL-817	XT	20AWG ×2C	7A 125V	
	QP-008		SPT-1	18AWG ×2C	10A 125V	
			SPT-2	18AWG ×2C	10A 125V	
			SPT-2	16AWG ×2C	13A 125V	
			NISPT-1	18AWG ×2C	10A 125V	
			NISPT-2	18AWG ×2C	10A 125V	
			Connector:			
QP-036						

	PLUG:	UL-817	SPT-1	18AWG ×2C	10A 125V		
	QP-008	IEC60 320 C7	SPT-2	18AWG ×2C	10A 125V		
			NISPT-1	18AWG ×2C	10A 125V		
			NISPT-2	18AWG ×2C	10A 125V		
			Connector:				
			QP-037				

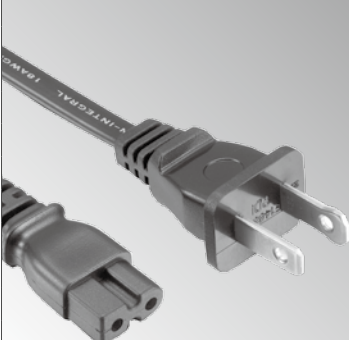
	PLUG:	UL-817	SPT-1/SPT-1W	18AWG ×2C	10A 125V		
	QP-008	IEC60 320 C7	SPT-2/SPT-2W	18AWG ×2C	10A 125V		
			NISPT-1	18AWG ×2C	10A 125V		
			NISPT-2	18AWG ×2C	10A 125V		
			Connector:				
			QP-045				

	PLUG:	UL-817	SPT-1/SPT-1W	18AWG ×2C	10A 125V		
	QP-008	IEC60 320 C7	SPT-2/SPT-2W	18AWG ×2C	10A 125V		
			NISPT-1	18AWG ×2C	10A 125V		
			NISPT-2	18AWG ×2C	10A 125V		
			Connector:				
			QP-019				



QP-008
QP-036



QP-008
QP-037



QP-008
QP-045

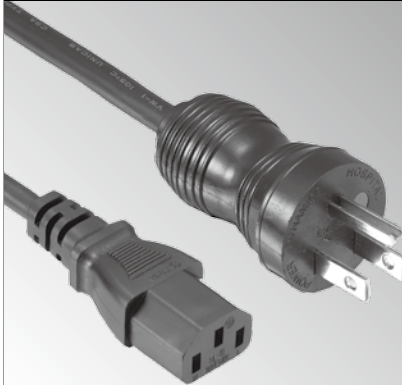

QP-008
QP-019

>> American (UL) type

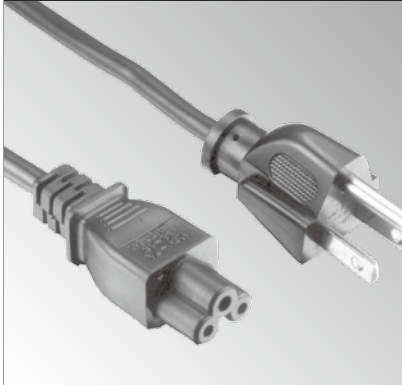
Style	Type No.	Standard	Available with Cords			Approvals	
	PLUG: QP-051	UL-817	Shielded & Unshielded Cord				
	Connector: QP-052	IEC 60320 C20 IEC 60320 C19	SJT/SJTW	16AWG ×3C	13A 125V		
			SJO/SJOW	16AWG ×3C	13A 125V		
			SJT/SJTW	14AWG ×3C	15A 125V		
			SJO/SJOW	14AWG ×3C	15A 125V		
			SJT/SJTW	12AWG ×3C	15A 125V		
			SJO/SJOW	12AWG ×3C	15A 125V		

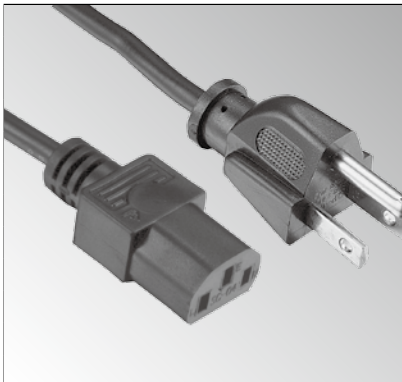

	PLUG: QP-049	UL-817	Shielded & Unshielded Cord			
	Hospital grade		SVT	18AWG ×3C	10A 125V	
			SJT/SJTW	18AWG ×3C	10A 125V	
			SJT/SJTW	16AWG ×3C	13A 125V	
			SJT/SJTW	14AWG ×3C	15A 125V	
	Connector: QP-007 (QC-01)					



	PLUG: QP-005	UL-817	Shielded & Unshielded Cord			
	Connector: QP-038	IEC60 320 C5	SPT-1/SPT-2	18AWG ×3C	10A 125V	
			SVT	18AWG ×3C	10A 125V	
			SJT	18AWG ×3C	10A 125V	

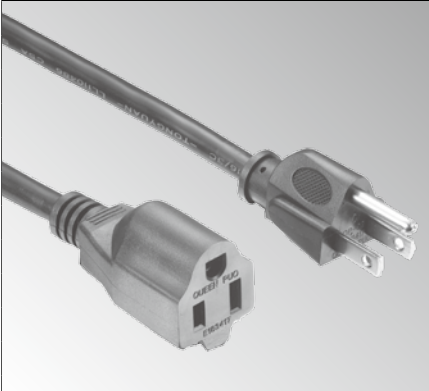

	PLUG: QP-005	UL-817	Shielded & Unshielded Cord			
	Connector: QP-007 (QC-01)	IEC 60320 C13	SVT	18AWG ×3C	10A 125V	
			SJT/SJTW	18AWG ×3C	10A 125V	
			SJ/SJO/SJOW	18AWG ×3C	10A 125V	
			SJT/SJTW	16AWG ×3C	13A 125V	
			SJ/SJO/SJOW	16AWG ×3C	13A 125V	
			SJT/SJTW	14AWG ×3C	15A 125V	
			SJ/SJO/SJOW	14AWG ×3C	15A 125V	

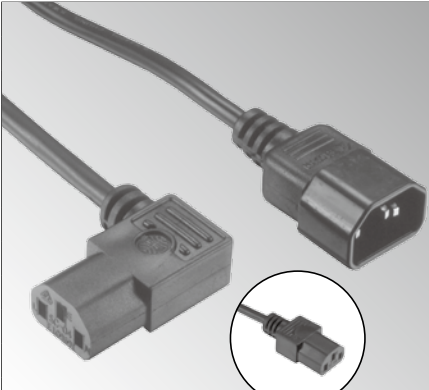

>> American (UL) type

Style	Type No.	Standard	Available with Cords	Approvals
-------	----------	----------	----------------------	-----------

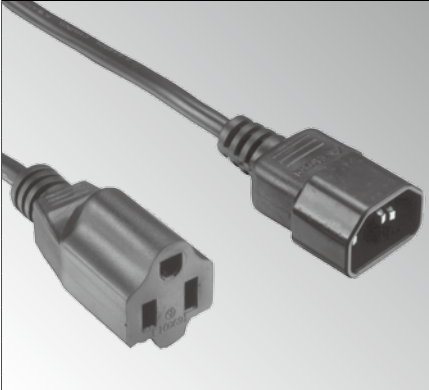
	PLUG: QP-005	UL-817 UL-498	Shielded & Unshielded Cord			
	Connector: QP-016		SVT	16AWG ×3C	13A 125V	
			SJT	16AWG ×3C	13A 125V	
			SPT-2	16AWG ×3C	13A 125V	
			SJT/SJTW	14AWG ×3C	15A 125V	

	PLUG: QP-015	UL-817 IEC60 320 C13 IEC60 320 C14	Shielded & Unshielded Cord			
	Connector: QP-018 QP-007 (QC-01)		SVT	18AWG ×3C	10A125/250V	
			SJT/SJTW	18AWG ×3C	10A125/250V	
			SJT/SJTW	16AWG ×3C	13A125/250V	
			SJT/SJTW	14AWG ×3C	15A125/250V	

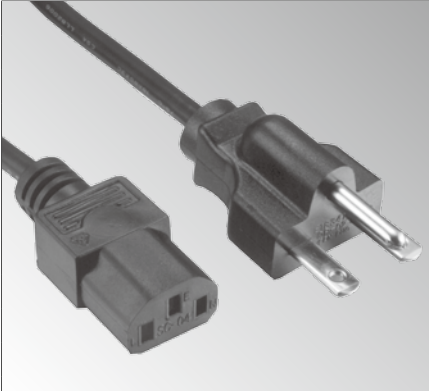
	PLUG: QP-015	UL-817 UL-498 IEC60 320 C14	Shielded & Unshielded Cord			 C-UL
	Connector: QP-016		SVT	16AWG ×3C	13A 125V	
			SJT	16AWG ×3C	13A 125V	
			SPT-2/SPT-2W	16AWG ×3C	13A 125V	
			SJT/SJTW	14AWG ×3C	15A 125V	

	PLUG: QP-040	UL-817 IEC60 320 C13	Shielded & Unshielded Cord			 C-UL
	Connector: QP-007 (QC-01)		SJT/SJTW	18AWG ×3C	10A 250V	
			SJTOW	18AWG ×3C	10A 250V	
			SJ/SJO/SJOW	18AWG ×3C	10A 250V	
			SJT/SJTW	16AWG ×3C	13A 250V	
			SJTO/SJTOW	16AWG ×3C	13A 250V	
			SJ/SJO/SJOW	16AWG ×3C	13A 250V	
			SJT/SJTW	14AWG ×3C	15A 250V	
			SJTO/SJTOW	14AWG ×3C	15A 250V	
			SJ/SJO/SJOW	14AWG ×3C	15A 250V	

QP-005
QP-016

QP-015
QP-018
(QP-007)

QP-015
QP-016

QP-040
QP-007

>> NEW TYPE

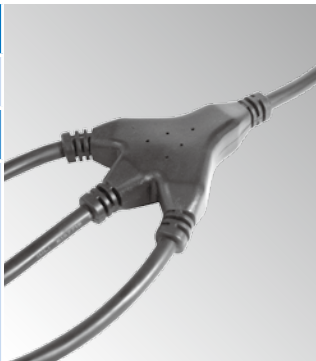
Item	
98-04	
Standard	
H05VV-F 1.00/1.50/2C H05RR-F 1.00/1.50/2C H05RR-F 0.75/3C H05RN-F 1.00/2C H05RN-F 0.75/3C H07RN-F 1.00/2C H07RN-F 1.00/3C (H)VCTF 0.75/2C (H)VCTF 1.25/3C (H)VCT 0.75/3C SVT 18AWG/2C SJT 18AWG/3C ST 16AWG/2C	

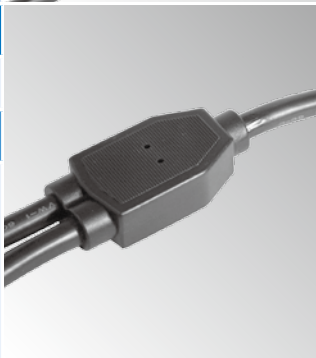
Item	
10040719	
Standard	
H03VVH2-F 0.75/2C H05VVH2-F 0.75/2C H05VV-F 1.00/2C H05VV-F 0.75/3C H05VV-F 1.00/3C H05RR-F 0.75/2C H05RR-F 1.00/2C H05RR-F 0.75/3C H05RR-F 1.00/3C H05RN-F 0.75/2C H05RN-F 1.00/2C H05RN-F 0.75/3C H05RN-F 1.00/3C (H)VFF 0.75/2C (H)VFF 2.00/2C (H)VCTF 0.75/3C NISPT-1 18AWG/2C SVT 18AWG/3C	

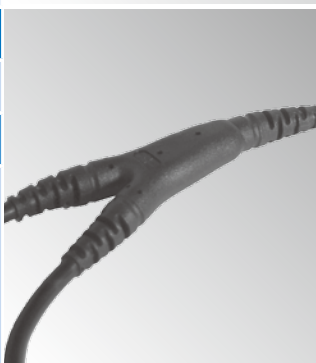
Item	
10020329	
Standard	
H03VVH2-F 0.75/2C H05VV-F 1.50/2C H05RR-F 0.75/2C H05RN-F 0.75/2C (H)VCTF 1.25/3C H05VV-F 1.50/3C H05RR-F 1.50/2C H07RN-F 1.00/2C (H)VCTF 2.00/3C	

Item	
QP018LD	
Standard	
SVT 18/3C SJT/SJTW/18/16/14X3C	

Item	
QP057	
Standard	
SVT 18/3C SJT/SJTW/SJO/SJOW/18/16/14X3C	

Item	
QP058	
Standard	
H05VVH2-F 2X1.0mm ² SJT/SJTW/SJO/SJOW/18/16/14X2C	

Item	
QP060	
Standard	
H03VVH2-F 2X0.75mm ² H05VVH2-F 2X0.75mm ² H05VV-F 2X0.75/1.0mm ²	

Item	
QP060R	
Standard	
H03VVH2-F 2X0.75mm ² H05VVH2-F 2X0.75mm ² H05VV-F 2X0.75/1.0mm ²	

Item	
QP061	
Standard	
SVT 18/3C SJT/SJTW/SJO/SJOW/18/16/14X3C	

Item	
QP062	
Standard	
SVT 18X2C SJT/SJTW/SJO/SJOW/18/16/14X2C	

>> NEW TYPE

Item	
QP063	
Standard	
H03VV-F 3G 0.75mm ² H05VV-F 3G 0.75mm ² H05VV-F 3G 1.0 mm ² H05VV-F 3G 1.5 mm ²	

Item	
L6-20P	
Standard	
SJT SJTW/SJ/SO/ST/16/14/12X3G	

Item	
QP066	
Standard	
H03VV-F 3G 0.75mm ² H05VV-F 3G 0.75mm ² H05VV-F 3G 1.0 mm ² H05VV-F 3G 1.5 mm ²	

Item	
QP067	
Standard	
H03VVH2-F 2X 0.75 mm ² H05VVH2-F 2X 1.0 mm ² SPT-1 18X2C SPT-2 18X2C	

Item	
L5-15P	
Standard	
SJT SJTW/SJ/SO/ST/18/16/14X3G	

Item	
L5-20P	
Standard	
SJT SJTW/SJ/SO/ST/16/14/12X3G	

» Plug Adapters Series

Item No.	
QP-905	
PLUG	
QP026	
CONNECTOR	
QP007(C13)	

Item No.	
QP-910	
PLUG	
QP004	
CONNECTOR	
QP045(C7)	

Item No.	
QP-915	
PLUG	
QP015(C14)	
CONNECTOR	
QP016	

Item No.	
QP-906	
PLUG	
QP009	
CONNECTOR	
QP007(C13)	

Item No.	
QP-911	
PLUG	
QP003	
CONNECTOR	
QP007(C13)	

Item No.	
QP-916	
PLUG	
QP015(C14)	
CONNECTOR	
QP038(C5)	

Item No.	
QP-907	
PLUG	
QP009	
CONNECTOR	
QP045(C7)	

Item No.	
QP-912	
PLUG	
QP003	
CONNECTOR	
QP038(C5)	

Item No.	
QP-917	
PLUG	
QP022	
CONNECTOR	
QP007(C13)	

Item No.	
QP-908	
PLUG	
QP004	
CONNECTOR	
QP007(C13)	

Item No.	
QP-913	
PLUG	
QP005	
CONNECTOR	
QP052(C19)	

Item No.	
QP-918	
PLUG	
QP024	
CONNECTOR	
QP007(C13)	

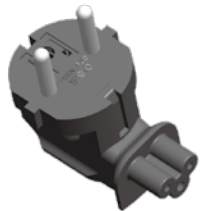
Item No.	
QP-909	
PLUG	
QP004	
CONNECTOR	
QP038(C5)	

Item No.	
QP-914	
PLUG	
QP005	
CONNECTOR	
QP007(C13)	

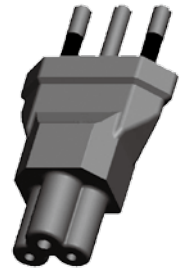
Item No.	
QP-919	
PLUG	
QP024	
CONNECTOR	
QP038(C5)	

>> Plug Adapters Series

Item No.	
QP-920	
PLUG	
QP026	
CONNECTOR	
QP038(C5)	

Item No.	
QP-925	
PLUG	
QP005	
CONNECTOR	
QP038(C5)	

Item No.	
QP-930	
PLUG	
QP006	
CONNECTOR	
QP038(C5)	

Item No.	
QP-921	
PLUG	
QP026	
CONNECTOR	
QP052(C19)	

Item No.	
QP-926	
PLUG	
QP005	
CONNECTOR	
QP062(C17)	

Item No.	
QP-931	
PLUG	
QP008(P)	
CONNECTOR	
QP019	

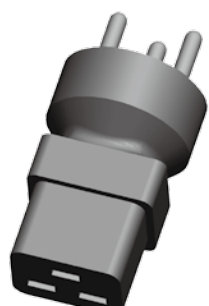
Item No.	
QP-922	
PLUG	
QP029	
CONNECTOR	
QP052(C19)	

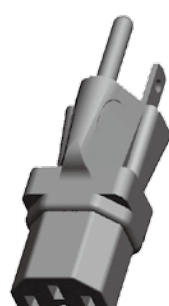
Item No.	
QP-927	
PLUG	
QP005	
CONNECTOR	
QP068(C15)	

Item No.	
QP-932	
PLUG	
QP008	
CONNECTOR	
QP045(C7)	

Item No.	
QP-923	
PLUG	
QP047	
CONNECTOR	
QP045(C7)	

Item No.	
QP-928	
PLUG	
QP006	
CONNECTOR	
QP007(C13)	

Item No.	
QP-933	
PLUG	
QP013	
CONNECTOR	
QP052(C19)	

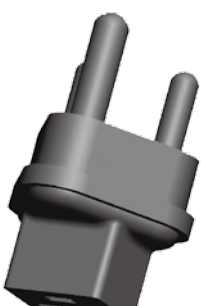
Item No.	
QP-924	
PLUG	
QP013	
CONNECTOR	
QP052(C19)	

Item No.	
QP-929	
PLUG	
QP006	
CONNECTOR	
QP052(C19)	

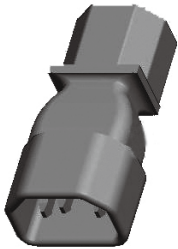
Item No.	
QP-934	
PLUG	
QP015(C14)	
CONNECTOR	
QP007(C13)	











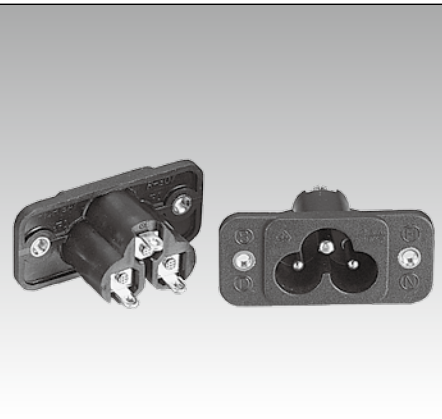



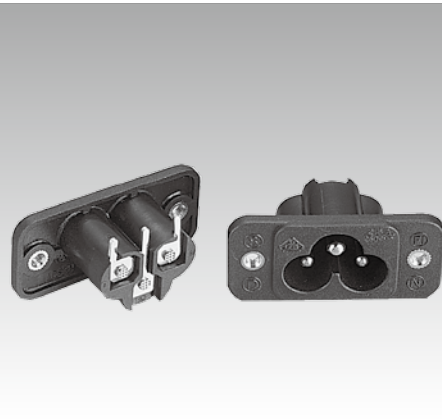
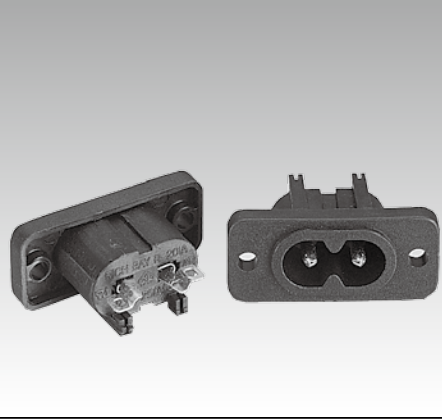

QP-301
QP-301-1

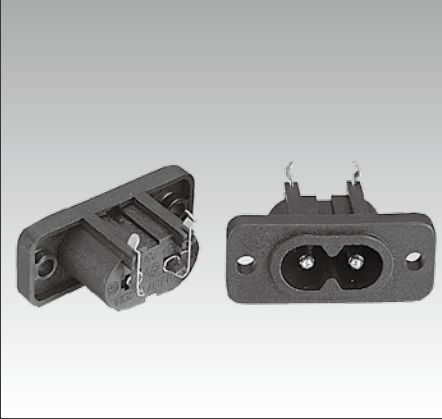
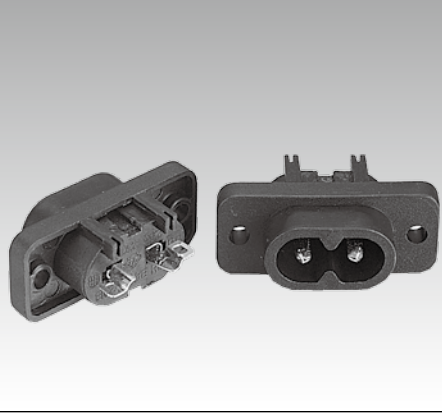
QP-302
QP-302-1



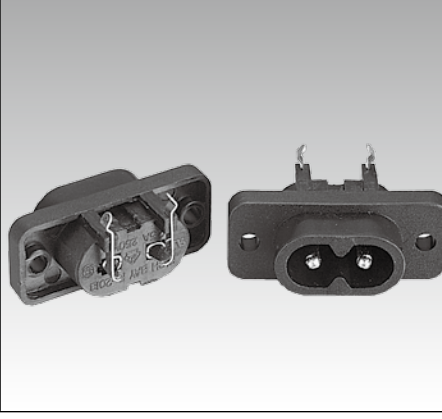
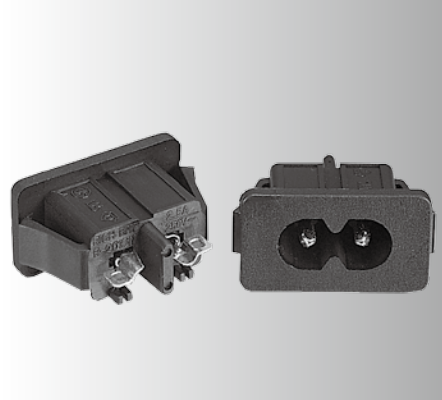



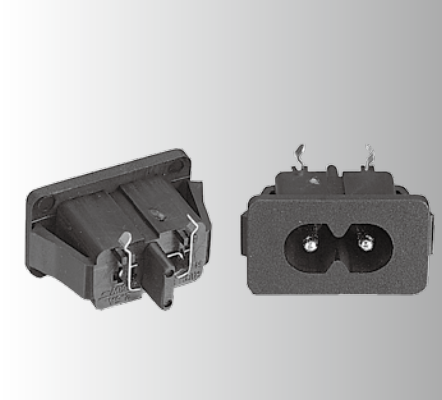

QP-303
QP-303-1

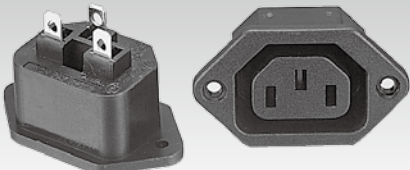
QP-304
QP-304-1

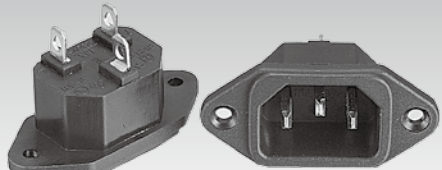
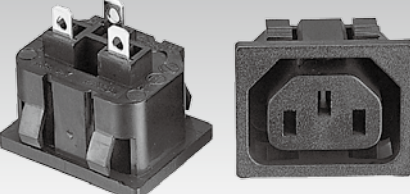
>> SOCKETS TYPE

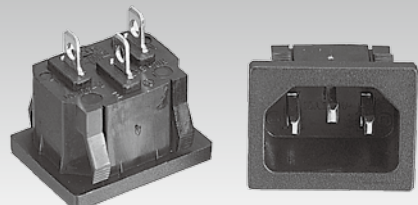
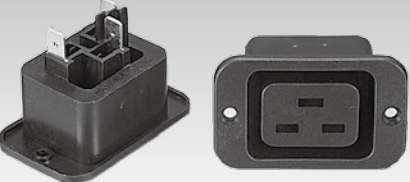
Style	Type No.	Approvals	Style	Type No.
	PLUG: QP-301	  		PLUG: QP-301-1
	PLUG: QP-302	  		PLUG: QP-302-1
	PLUG: QP-303	  		PLUG: QP-303-1
	PLUG: QP-304	  		PLUG: QP-304-1

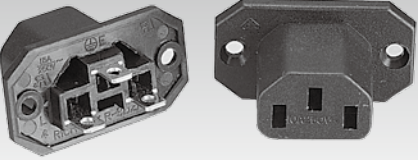
>> SOCKETS TYPE

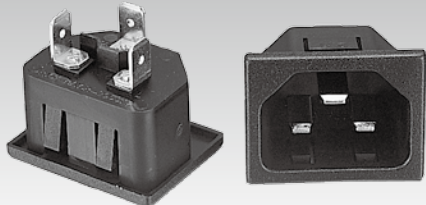
Style	Type No.	Approvals	Style	Type No.
	PLUG: QP-401			PLUG: QP-501
	PLUG: QP-402			PLUG: QP-502
	PLUG: QP-601			PLUG: QP-701
	PLUG: QP-403			PLUG: QP-702

QP-401
QP-402

QP-601
QP-403

QP-501
QP-502

QP-701
QP-702









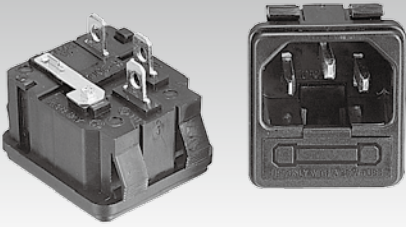

QP-801
QP-901

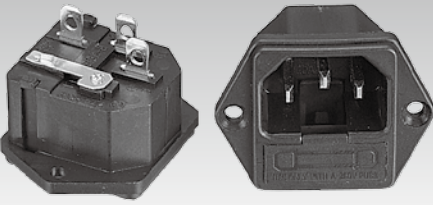
QP-802
QP-902

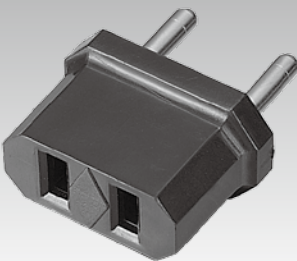
QP-903
QP-906

QP-904
QP-303, 304

>> SOCKETS TYPE

Style	Type No.	Approvals	Style	Type No.
	PLUG: QP-801 FUSE			PLUG: QP-901
	PLUG: QP-802 FUSE			PLUG: QP-902
	QP-903 LINE SWITCH			QP-906 LINE SWITCH LINE SWITCH
	QP-904 LINE SWITCH			QP-303W QP-303B QP-304W QP-304B

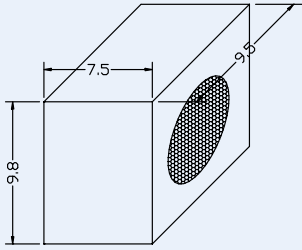
Item 1	
7725	
Standard	
SVT 18/3G	

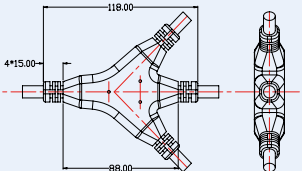
Item 2	
98-04	
Standard	
SVT 18/3G SJT 18/3G SJT 16/3G SJT 14/3G	

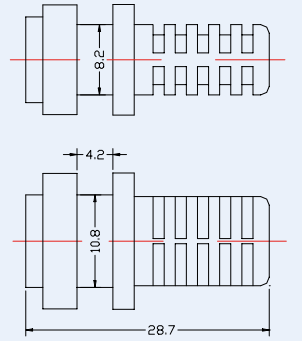
Item 3	
10000103	
Standard	
SPT-2 18/2C	

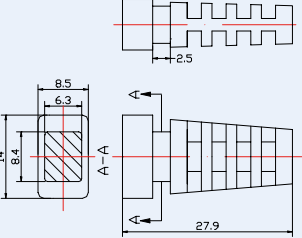
Item 4	
10000814	
Standard	
SPT-1 18/2C SPT-2 18/2C SVT 18/2C	

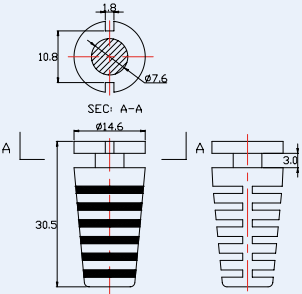
Item 5	
10001206	
Standard	
SVT 18/3G H03VV-F 0.75/3G	

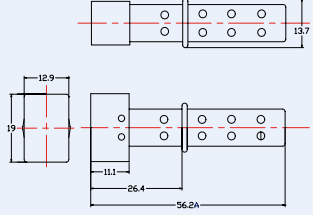
Item 6	
10010627	
Standard	
SJT 18/3G H05VV-F 1.5/2C (H)VCTF 1.25/2C	

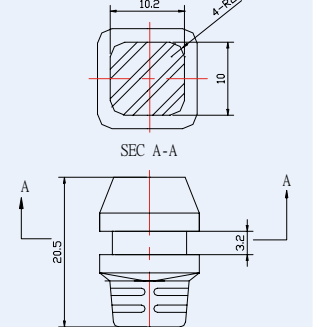
Item 7	
10011115	
Standard	
(H)VFF 0.75/2C H05VVH2-F 0.75/2C HPN 18/2C	

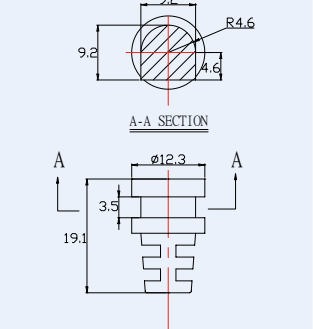
Item 8	
10011118	
Standard	
SPT-1 18/2C (H)VFF 0.75/2C	

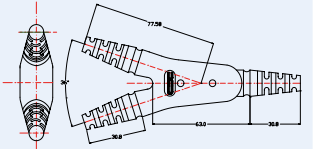
Item 9	
10020329	
Standard	
SVT 18/3G SJT 18/3G H(VCTF) 1.25/2G H03VVH2-F 0.75/2C	

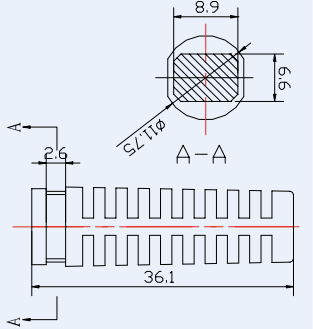
Item 10	
10020331	
Standard	
H03VV-F 0.75/2C SVT 18/2C SVT 18/3G H05VV-F 1.0/2C H05VV-F 0.75/3G H03VVH2-F 0.75/3G	

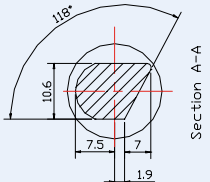
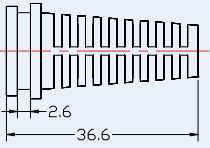
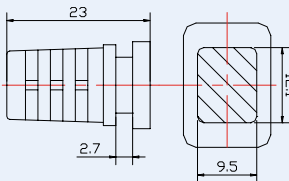
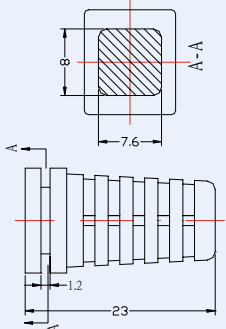
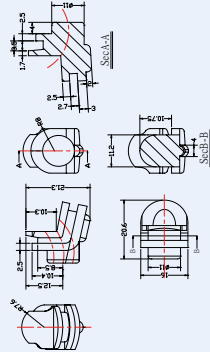
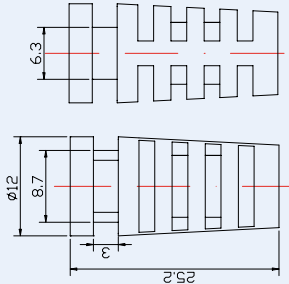
Item 11	
10020409	
Standard	
H03VVH2-F 0.75/2C H05VVH2-F 0.75/2C SPT-1 18/2C SPT-2 18/2C	
Item 12	
10020713	
Standard	
H05VV-F 0.75/3G H03VV-F 0.75/3G SJT 18/3G H05VV-F 1.0/3G	
Item 13	
10020930	
Standard	
H03VVH2-F 0.75/2C HPN 18/2C SPT-2 18/2C	
Item 15	
10021128	
Standard	
H05VV-F 1.0/4G	
Item 16	
10030221	
Standard	
H03VVH2-F 0.75/2C H03VV-F 0.75/2C (H)VFF 1.25/2C SPT-2 18/2C	

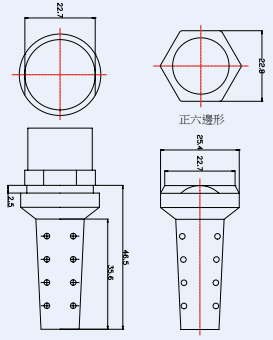
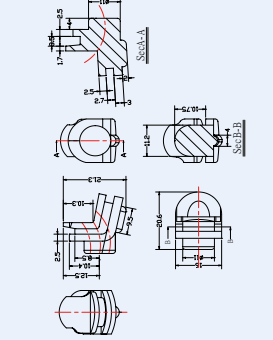
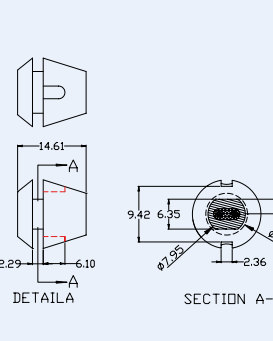
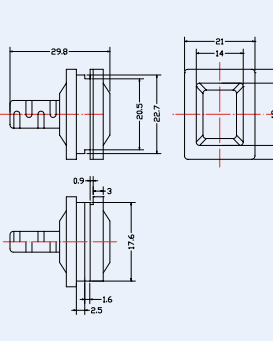
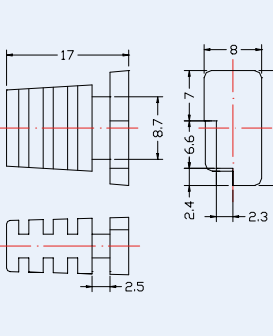
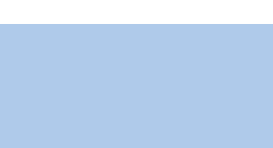
Item 17	
10030222	
Standard	
H05VV-F 1.5/3G H05VV-F 3G 1.0mm ² (H)VCTF 2.0/3G SJT 14/3G (H)VCT 0.75/3G	
Item 18	
10030224	
Standard	
H05VV-F 0.75/3G	
Item 19	
11030421	
Standard	
NISPT-2 18/2C SPT-2 18/2C	
Item 20	
10030426	
Standard	
SPT-2 18/2C (H)VFF 0.75/2C (H)VFF 2.0/2C	
Item 21	
10031130	
Standard	
SPT-2 18/3G	



Item 22	
10040408(9)	
Standard	
SP-1 18/2C H03VVH2-F 0.75/2C SPT-2 18/2C SVT 18/3G SP-1 18/3G NISPT-2 18/2C H05VV-F 0.75/3G	
Item 23	
10040608	
Standard	
H03VVH2-F H05VVH2-F VCTFK 1.25/2C SPT-2 18/2C H03VV-F 0.75/3G	
Item 24	
10040719	
Standard	
SJT 14/3G SJT 16/3G	
Item 25	
10040910	
Standard	
H03VV-F 0.75/2C SVT 18/3G H05VV-F 0.75/3G H03VVH2-F 0.75/2C	
Item 26	
10041106	
Standard	
SJT 18/3G H05VV-F 1.5/2C (H)VCTF 1.25/3G SVT 18/3G H05RR(N)-F 0.75/2C SPT-2 18/3G HPN 16/3G	

Item 27	
10050227	
Standard	
VCTFK 0.75/2C H05VVH2-F 1.0/2C SPT-1 18/2C VFF 0.75/2C H03VVH2-F 0.75/2C	
Item 29	
10891128	
Standard	
H03VV-F 0.75/2C H03VVH2-F 0.75/2C	
Item 30	
10990610	
Standard	
SPT-1 18/2C SPT-2 18/2C	
Item 31	
10990624	
Standard	
SPT-2 18/2C	
Item 32	
11020105	
Standard	
H05VV-F 1.0/3G SJT 18/2C	

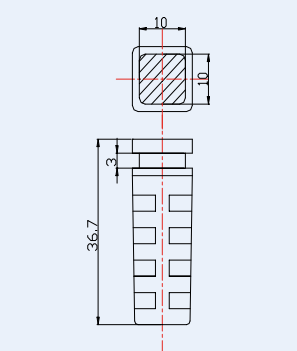
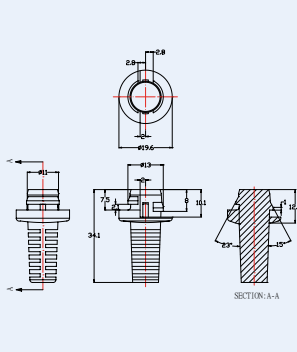
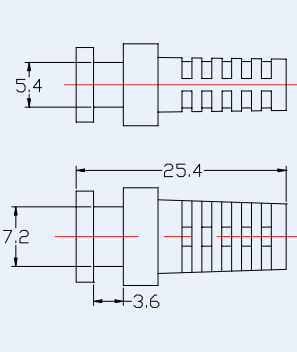
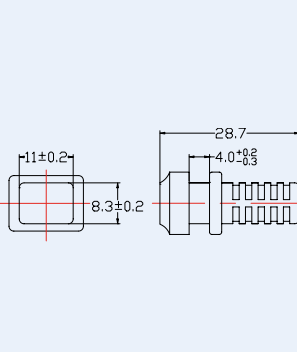
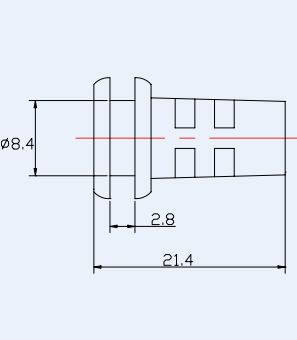
Item 33	
10040621	
Standard	
H05VV-F 1.5/3G (H)VCTF 2.0/3G SJOW 16/3G SJT 18/3G H05VV-F 1.5/2C H(VCTF) 1.25/2G SJT 14/3G SVT 18/3G	
Item 34	
11030511	
Standard	
H03VVH2-F 0.75/2C H05VVH2-F 0.75/2C	
Item 35	
11030815	
Standard	
H03VVH2-F	
Item 36	
11030904	
Standard	
SPT-1 NISPT-1 SPT-2 NISPT-2	
Item 37	
11031107	
Standard	
SVT 18/2C H05RR(N) 0.75/2C H05VV-F 0.75/3G H03VVH2-F 0.75/2C H05VVH2-F 0.75/2C	

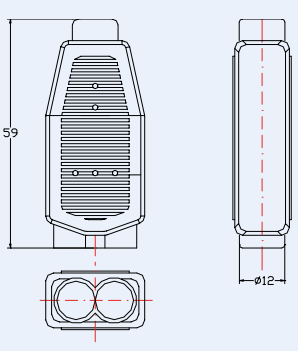
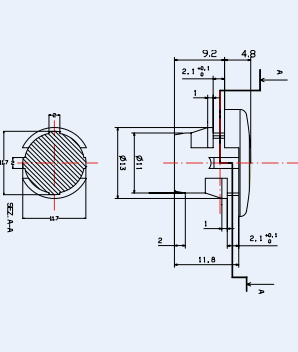
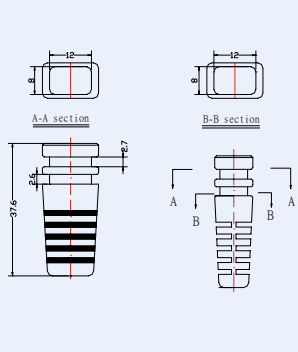
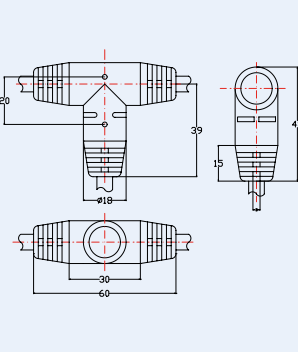
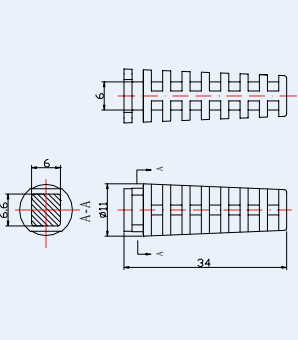
Item 38	
16020510	
Standard	
SJT 18/3G H05VV-F 0.75/3G H05VVH2-F 0.75/2C H03VVH2-F 0.75/2C (N)SPT-1 18/2C (H)VFF 0.75/2C SPT-2 18/2C HPN 18/2C (H)VFF 2.0/2C	
Item 39	
27030506	
Standard	
Item 40	
10001216	
Standard	
(H)VCTFK 2.0/2C	
Item 41	
10020423	
Standard	
SJT 14/3G SPT-2 18/2C HPN 18/2C (H)VFF 2.0/2C	
Item 42	
A-40#	
Standard	
H03VVH2-F 0.75/2C	



Item 43	
K970638	
Standard	
SPT-1 18/2C (H)VFF 0.75/2C	
Item 44	
K980413	
Standard	
H05VV-F 1.0/3G SJT 18/2C	
Item 45	
KB-1120	
Standard	
H03VVH2-F 0.75/2C H05VVH2-F 0.75/2C	
Item 46	
YS9416	
Standard	
SPT-1 18/2C H03VVH2-F 0.75/2C	
Item 47	
YSH0906140 YSH0906139	
Standard	
H05VVH2-F 1.0/2C (H)VCTFK 0.75/2C	

Item 48	
YSH0910192	
Standard	
VCTF 0.75/2C	
Item 49	
YSH5430	
Standard	
SPT-1 18/2C SPT-2 18/2C	
Item 50	
YSH543818	
Standard	
SVT 18/3G H03VV-F 0.75/3G	
Item 51	
YSH859A	
Standard	
SPT-2 18/2C	
Item 52	
YSH859L	
Standard	
SPT-2 16/2C	

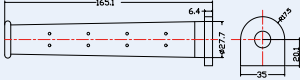
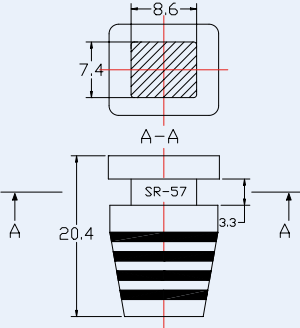
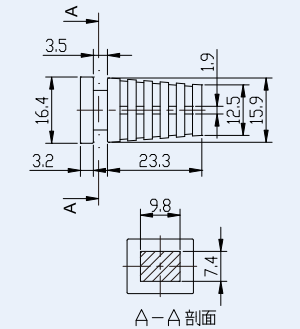
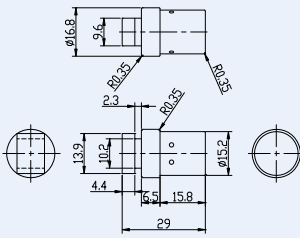
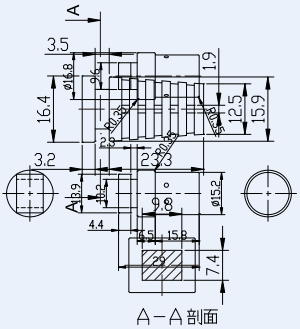
Item 53	
10040617	
Standard	
STW 14/2C	
Item 54	
10000313	
Standard	
SVT 18/3G H03VV-F 0.75/3G H05VV-F 1.0/2C (H)VCTF 0.75/2C	
Item 55	
98-033	
Standard	
H05VV-F 0.75/3G H05VV-F 1.0/3G	
Item 56	
98-034	
Standard	
SJTW 18/6C	
Item 57	
98-036	
Standard	
VCTFK 0.75/2C VCTFK 1.25/2C VCTFK 2.0/2C VCTFK 0.75/2C	

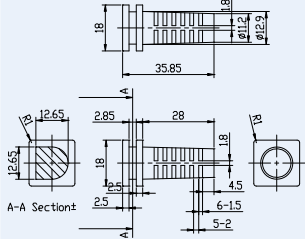
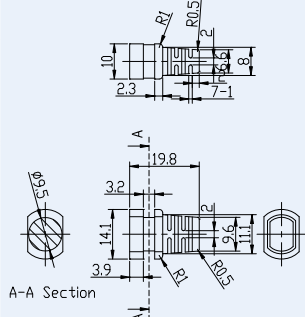
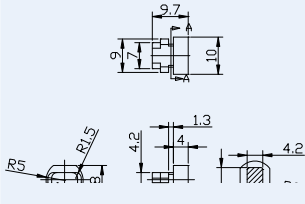
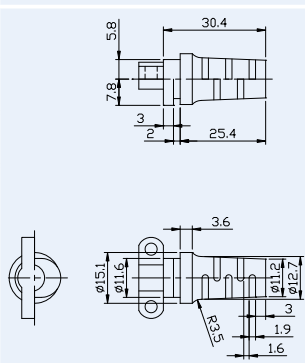
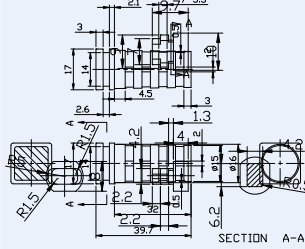
Item 58	
98-041	
Standard	
H03VV-F 0.75/3G H05VV-F 0.75/3G	
Item 59	
98-043	
Standard	
H03VVH2-F 0.75/2C	
Item 60	
98-046	
Standard	
H03VVH2-F 0.75/2C	
Item 61	
98-050	
Standard	
H03VVH2-F 0.75/2C H05VV-F 0.75/3G	
Item 62	
98-052	
Standard	
SJO 14/3 SJO 12/3	

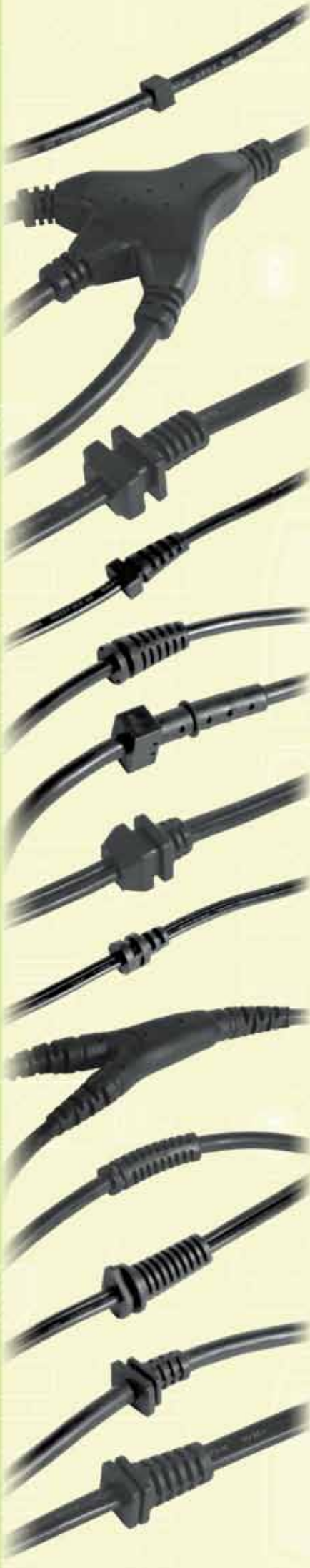

7725

98-04

10000103

10000814

10001206

10010627

10011115

10011118

10020329

10020331

10020409

10020713

10020930

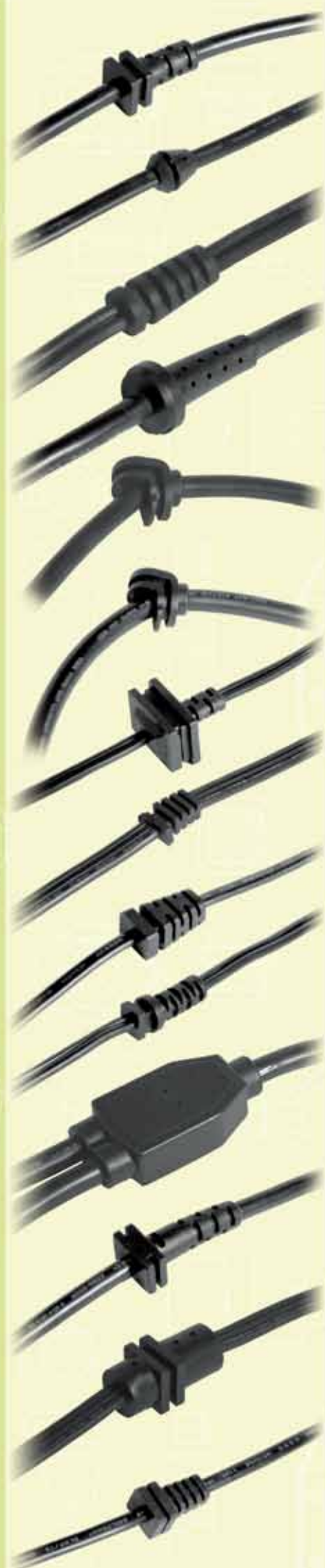

10021024

11030421

10030221

10030222

10030224

10021128

10030426

10031130

1004040(8)9

10040608

10040719

10040910

10041106

10050227

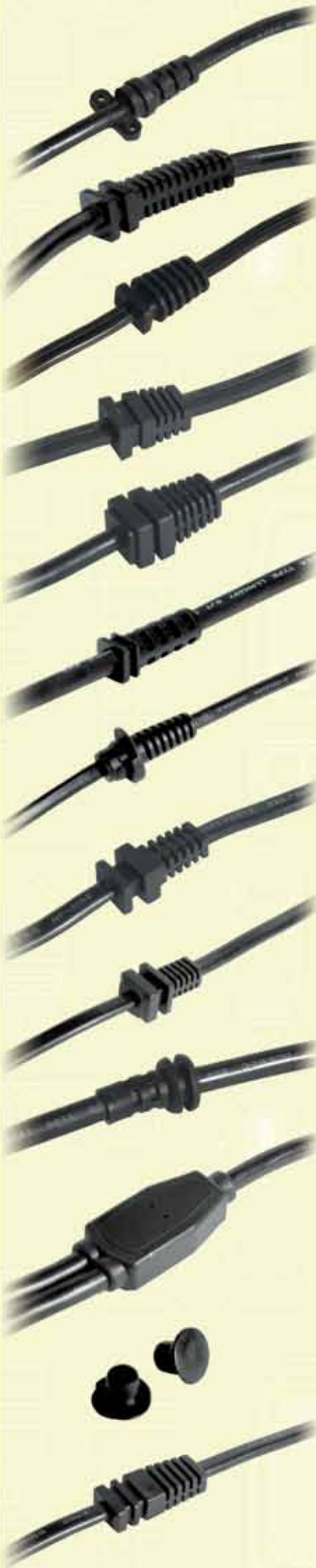

10880818

10891128

10990610

10990624

11020105

10040621

11030511

11030815

11030904

11031107

16020510

27030506

10001216



10020423

A-40

K970638

K930413

KB-1120

YSH9416

YSH0906140

YSH0910192

YSH5430

YSH543818

YSH859A

YSH859L

10040617

10000313

>> World Power Supply Cords Style Specification

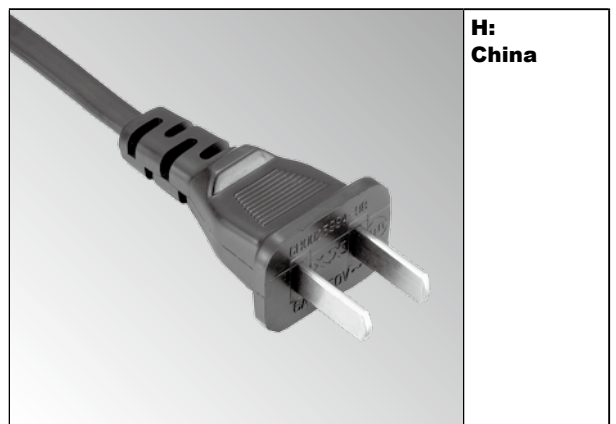
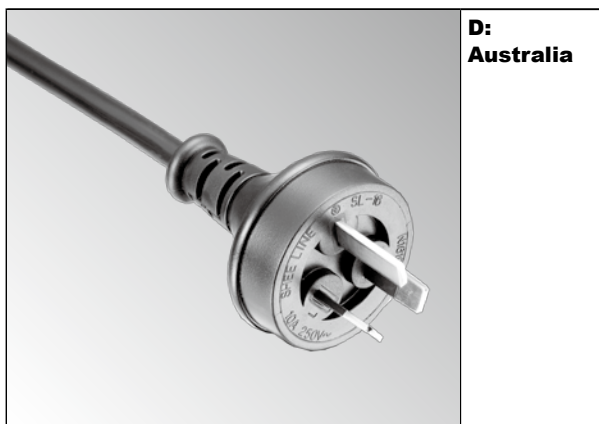
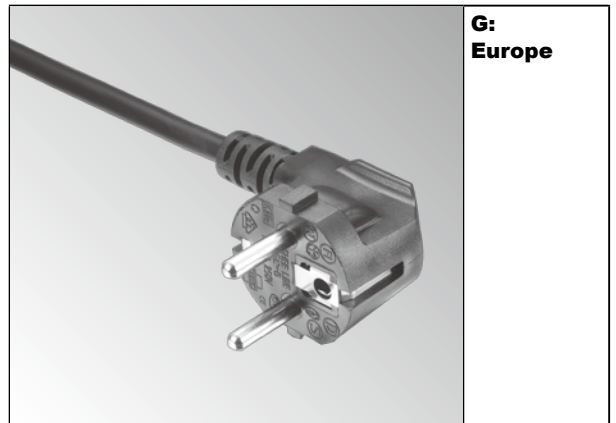
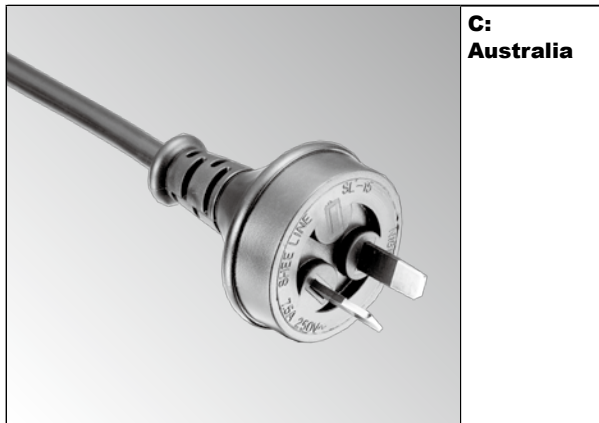
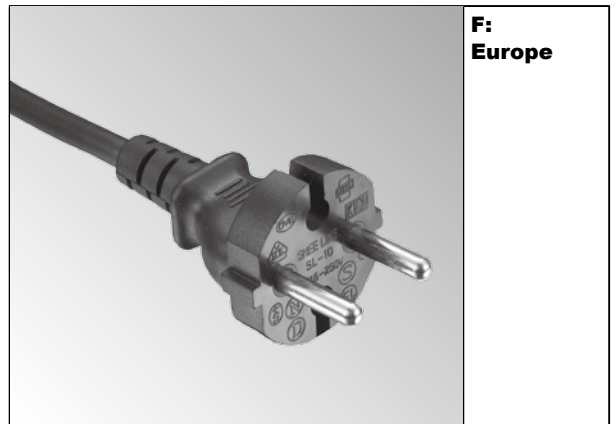
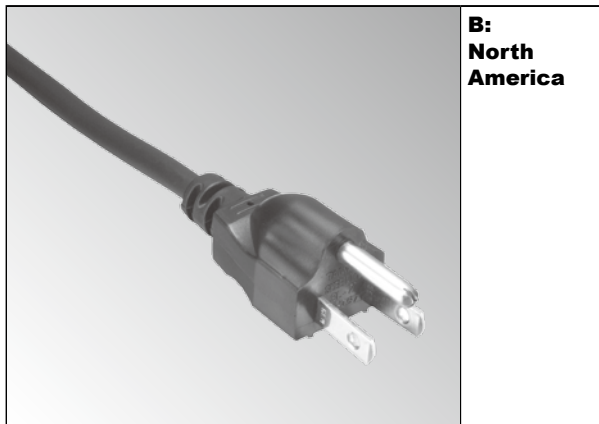
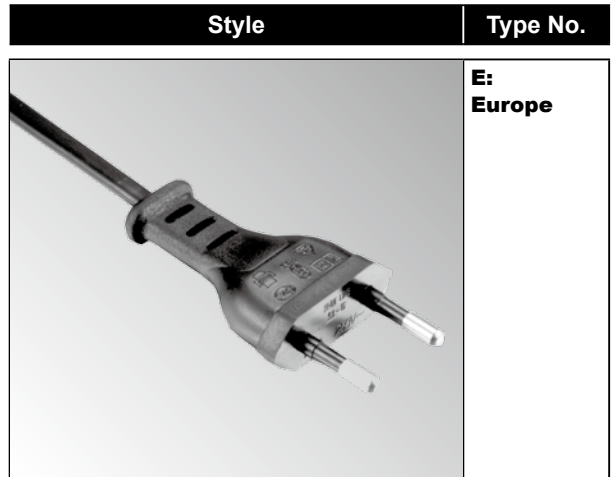
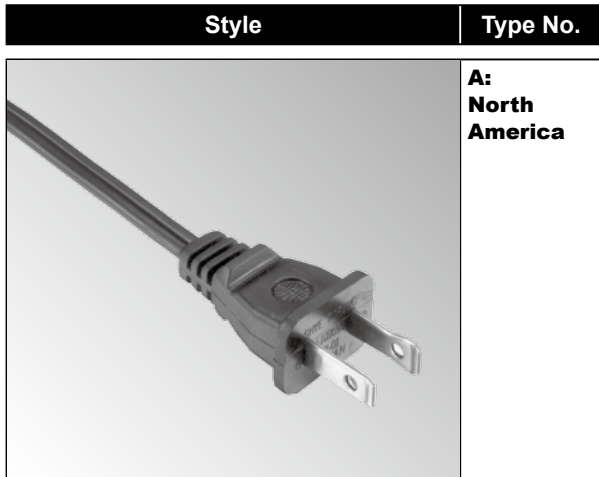

>> World Power Supply Cords Style Specification

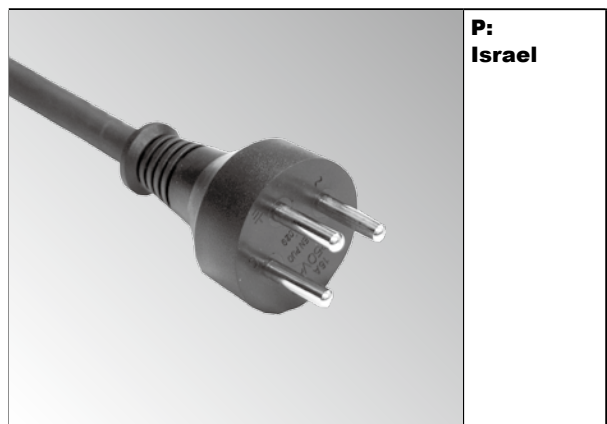
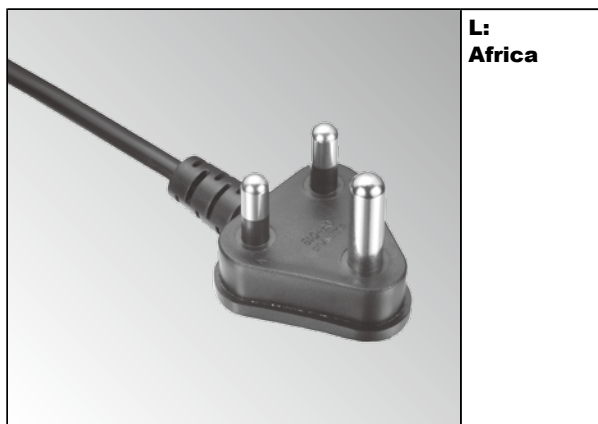
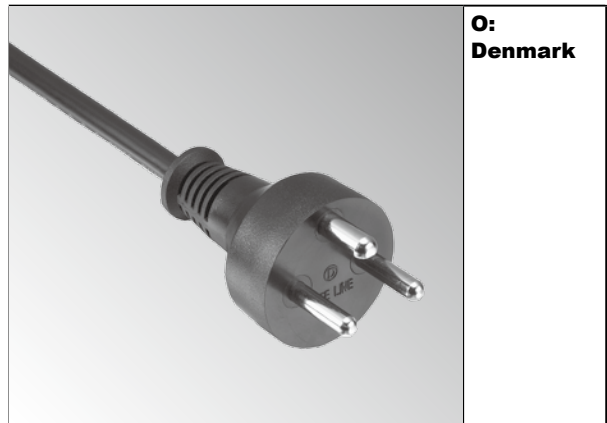
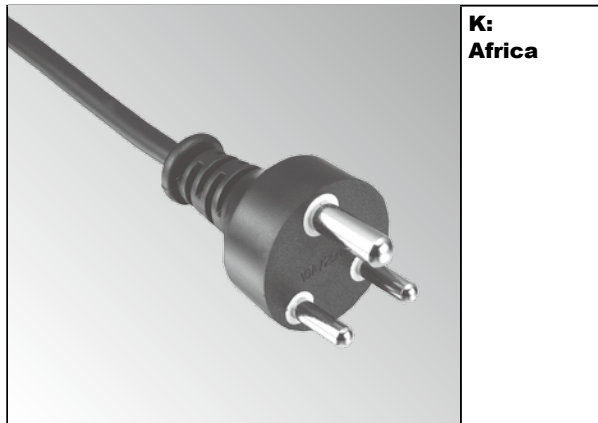
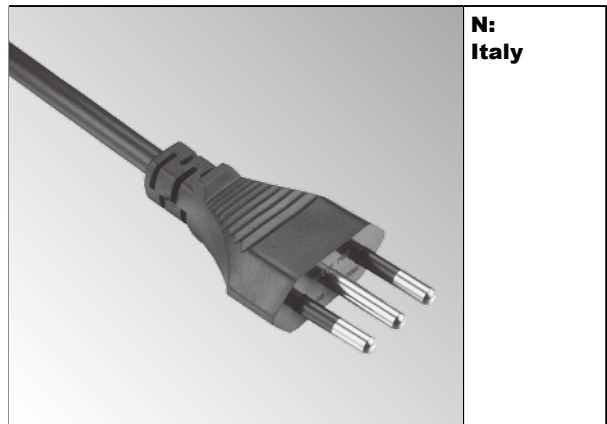
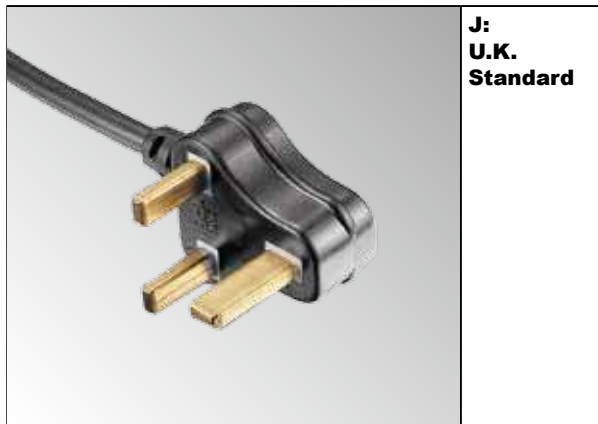
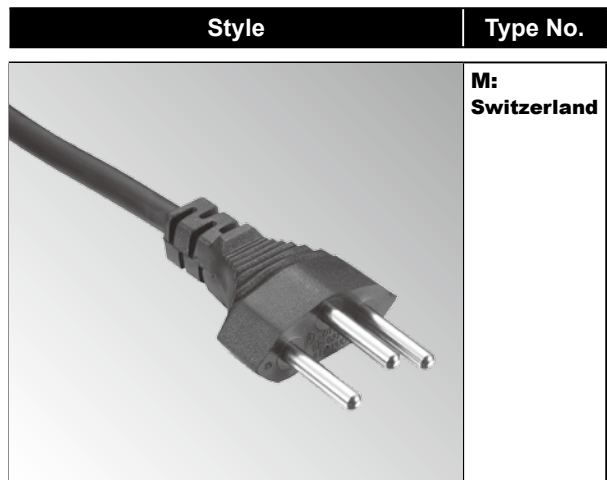
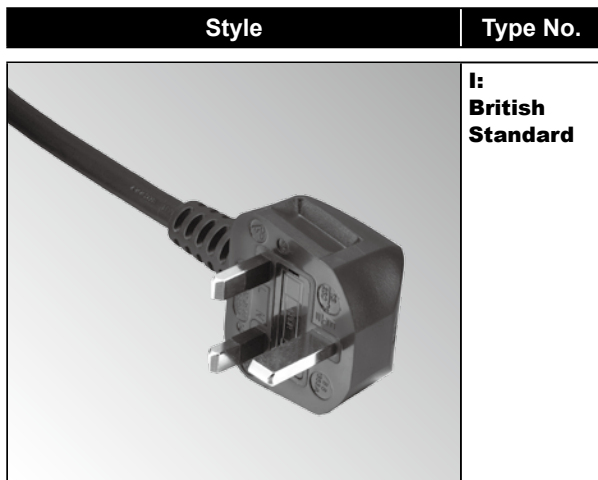

世界各國插頭形式／電壓頻率參考表

>> World Power Supply Cords Style Specification

亞洲 ASIA

國名	型式	電壓、頻率
台灣 Taiwan	A,B	110V 60HZ
中國 China	D,H	220V 50HZ
香港 Hongkong	I,J	220V 50HZ
日本 Japan	A,B	100V 60HZ
韓國 Korea	G	220V 60HZ
越南 Vietnam	A,B,E,G	220V 50HZ
寮國 Laso	E	220V 50HZ
泰國 Thailand	A,B	220V 50HZ
緬甸 Burma	E	220V 50HZ
馬來西亞 Malaysia	I,J	240V 50HZ
新加坡 Singapore	I,J	230V 50HZ
印尼 Indonesia	E,G	220V 50HZ
菲律賓 Philippines	A,B	220V 60HZ
汶萊 Brunei Darussalam	I,J	220V 50HZ
印度 India	E,I,J	230V 50HZ
尼泊爾 Nepal	A,B,E,G	220V 50HZ
巴基斯坦 Pakistan	E,G	230V 50HZ
孟加拉 Bengal	E	230V 50HZ
斯里蘭卡 SriLanka	I,J	230V 50HZ
馬爾地夫 Maldives	E,I,J	220V 50HZ
阿富汗 Afghanistan	E,G	220V 50HZ
伊朗 Iran	E,I,J	220V 50HZ
伊拉克 Iraq	E,I,J	220V 50HZ
科威特 Kuwait	E,I,J	240V 50HZ
巴林 Bahrain	A,B	110V 60HZ
卡達 Qatar	K	240V 50HZ
阿拉伯聯邦 Arabia	I,J	220V 50HZ
沙烏地阿拉伯 Saudi Arabia	E,G,I,J	220V 50HZ
葉門 Yemen	I,J	220V 50HZ
敘利亞 Syrian	E	220V 50HZ
約旦 Jordan	I,J	220V 50HZ
土耳其 Turkey	E,G	220V 50HZ
黎巴嫩 Lebanon	E	220V 50HZ
以色列 Israel	P	230V 50HZ
塞普勒斯 Cyprus	I,J	240V 50HZ
杜拜 Dubai	G	220V 50HZ
關島 Guam	A,B	110V 60HZ

美洲 AMERICA

國名	型式	電壓、頻率
美國 USA	A,B	110V 60HZ
加拿大 Canada	A,B	115V 60HZ
墨西哥 Mexico	A,B	250V 60HZ
瓜地馬拉 Guatemala	A,B	110V 60HZ
宏都拉斯 Honduras	A,B	120V 60HZ
薩爾瓦多 El Salvador	A,B	110V 60HZ
尼加拉瓜 Nicaragua	A,B	120V 60HZ

哥斯大黎加 Costa Rica	A,B	110V 60HZ
巴拿馬 Panama	A,B	120V 60HZ
古巴 Cuba	A,B	110V 60HZ
海地 Haiti	A,B	110V 60HZ
多明尼加 Dominican	A,B	115V 60HZ
牙買加 Jamaica	E	220V 50HZ
巴哈馬 Bahamas	A,B	110V 60HZ
哥倫比亞 Colombia	A,B	115V 60HZ
厄瓜多爾 Ecuador	A,B	110V 60HZ
委內瑞拉 Venezuela	A,B	110V 60HZ
秘魯 Peru	A,B,E	110V 60HZ
玻利維亞 Bolivia	A,B	110V 60HZ
智利 Chile	N	220V 50HZ
巴西 Brazil	A,B	115V 60HZ
巴拉圭 Paraguay	E	110V 60HZ
烏拉圭 Uruguay	A,B,E	110V 60HZ
阿根廷 Argentine	C,D	220V 50HZ

大洋洲 OCEANIA

澳大利亞 Australia	C,D	240V 50HZ
紐西蘭 New Zealand	C,D	240V 50HZ
斐濟 Fiji	C,D	240V 50HZ
東加 Tonga	C,D	240V 50HZ
所羅門群島 Solomon Islands	C,D	240V 50HZ

歐洲 EUROPE

國名	型式	電壓、頻率
芬蘭 Finland	E,F,G	220V 50HZ
瑞典 Sweden	E,F,G	220V 50HZ
挪威 Norway	E,F,G	230V 50HZ
冰島 Iceland	G	220V 50HZ
丹麥 Denmark	E,F,G,O	220V 50HZ
波蘭 Polish	E,F,G	220V 50HZ
愛沙尼亞 Estonia	E,F,G	220V 50HZ
立陶宛 Lithuania	E,F,G	220V 50HZ
羅馬尼亞 Romania	E,F,G	220V 50HZ
捷克 Czechoslovak	G	220V 50HZ
匈牙利 Hungarian	E,F,G	220V 50HZ
奧地利 Austria	E,F,G	220V 50HZ
瑞士 Swiss	M	220V 50HZ
法國 French	E,F,G	220V 50HZ
摩納哥 Monaco	E,F,G	220V 50HZ
盧森堡 Luxembourg	E,F,G	220V 50HZ
比利時 Belgium	E,F,G	220V 50HZ
荷蘭 Netherlands	E,F,G	220V 50HZ
英國 U.K	I,J	240V 50HZ
愛爾蘭 Ireland	E,F,G,I,J	220V 50HZ
葡萄牙 Portugal	E,F,G	220V 50HZ
西班牙 Spanish	G	220V 50HZ
義大利 Italian	N,G	220V 50HZ

德國 Germany	E,F,G	220V 50HZ
保加利亞 Bulgaria	E,F,G	220V 50HZ
阿爾巴尼亞 Albania	E,F,G	220V 50HZ
希臘 Hellenic	G	220V 50HZ
俄羅斯 Russia	E,F,G	220V 50HZ
烏克蘭 Ukraine	E,F,G	220V 50HZ
哈薩克 Kazakhstan	E,F,G	220V 50HZ
白俄羅斯 Belarus	E,F,G	220V 50HZ

非洲 AFRICA

國名	型式	電壓、頻率
埃及 Egypt	E,I,J	220V 50HZ
利比亞 Libyan	E,G	125V 50HZ
阿爾及利亞 Algeria	G	220V 50HZ
突尼西亞 Tunisia	E,G	230V 50HZ
摩納哥 Morocco	E,G	220V 50HZ
毛利塔尼亞 Mauritania	E,G	220V 50HZ
馬利 Mali	E,G	220V 50HZ
尼日 Nige	G	220V 50HZ
查德 Chad	G	220V 50HZ
塞內加爾 Senegal	E,F,G	230V 50HZ
獅子山國 Sierra Leone	G,I,J	220V 50HZ
賴比瑞亞 Liberia	E	220V 50HZ
象牙海岸 Ivory Coast	E,F,G	220V 50HZ
迦納 Ghana	E,I,K	220V 50HZ
奈及利亞 Nigeria	I,J	220V 50HZ
中非共和國 Central African	E,G	220V 50HZ
喀麥隆 Cameroon	E,F,G	220V 50HZ
加彭 Gabonese	G	220V 50HZ
剛果 Congo	E	220V 50HZ
薩伊 Zaire	G	220V 50HZ
安哥拉 Angola	E,G	220V 50HZ
納米比亞 Namibia	I,J	220V 50HZ
尚比亞 Zambia	I,J	220V 50HZ
辛巴威 Zimbabwe	I,J,K	220V 50HZ
波札納 Botswana	I,J,K	220V 50HZ
史瓦濟蘭 Swaziland	I,J	220V 50HZ
南非共和國 South Africa	L	220V 50HZ
莫三比克 Mozambique	I,J	220V 50HZ
坦尚尼亞 Tanzania	I,J	230V 50HZ
馬達加斯加 Madagascar	E,G	220V 50HZ
蒲隆地 Burundi	E,G	220V 50HZ
盧安達 Rwanda	E	220V 50HZ
肯亞 Kenya	E,I,J	240V 50HZ
索馬利亞 Somali	E,G	
衣索比亞 Ethiopia	E,G	220V 50HZ
模里西亞 Mauritius	I,J	230V 50HZ
烏干達 Uganda	E	230V 50HZ
蘇利南 Surinam	E,G	220V 60HZ