

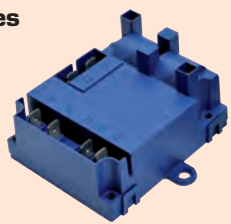

Re-igniters

800 series



Outlets: 1 - 2
Supply Voltage (VAC) 220 - 240
Optional: 800 series transformer
Tabs: LV 6,3x0,8 - HV 2,8x0,8



800 series

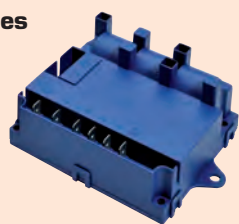

Outlets: 3
Supply Voltage (VAC) 220 - 240
Optional: 800 series transformer
Tabs: LV 6,3x0,8 - HV 2,8x0,8



800 series transformer



Outlets: 4 - 6
Tabs: LV 6,3x0,8 - HV 2,8x0,8



650 series

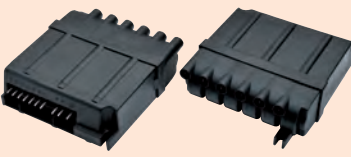

Outlets: 4 - 5 - 6
Supply Voltage (VAC) 120; 220 - 240
Tabs: LV 11 way connector
 HV 2,8x0,8



140 series - screw/snap



Outlets: 1
Supply Voltage (VAC) 120
Tabs: LV 6,3x0,8 - HV 2,8x0,8





Switch harnesses

930 series - push





Layout: on demand
Supply Voltage (VAC) 250
Current Rating: 0,1 A
Suitable for a wide range of gas taps

925 series - push

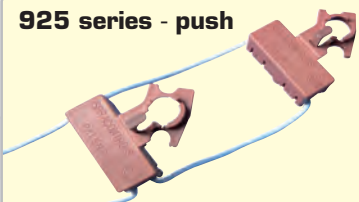

Layout: on demand
Supply Voltage (VAC) 250
Current Rating: 0,1 A
Suitable for BSI gas taps

915 series - push



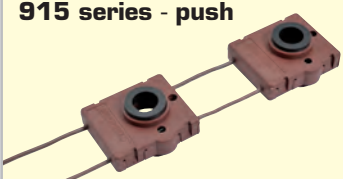

Layout: on demand
Supply Voltage (VAC) 250
Current Rating: 0,1 A
Suitable for SABAF gas taps



905 series - push/rotative



Layout: on demand
Supply Voltage (VAC) 250
Current Rating: 0,1 A
Suitable for a wide range of gas taps

905 series - control on single tap

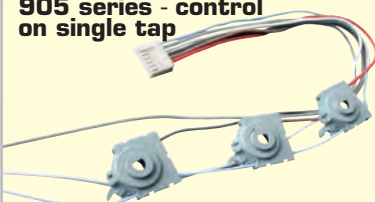

Layout: on demand
Supply Voltage (VAC) 250
Current Rating: 0,1 A
Suitable for a wide range of gas taps



Led display

Multiple modules

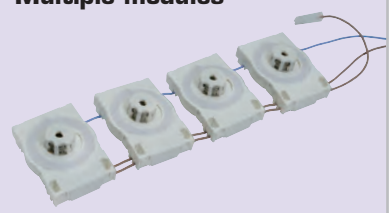

with integrated switch for ignition
Design: on demand

Single module



Design: on demand

Oven cavity lighting

Strip led

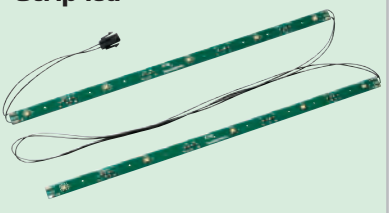

Design: on demand

Legenda

LV: Low Voltage
 HV: High Voltage

For any requests and/or clarifications about products here showed, please address your enquiries to info@itwispracontrols.com or call +39 0332 733311