

Stand Alone gas igniters

2000 series - screw



Outlets: 2 - 4 - 5 - 6
Supply Voltage (VAC) 120; 220 - 240
Tabs: LV 6,3x0,8 - HV 2,8x0,8

2000 series - snap



Outlets: 2 - 4 - 5 - 6
Supply Voltage (VAC) 120; 220 - 240
Tabs: LV 6,3x0,8 - HV 2,8x0,8

1000 series - screw

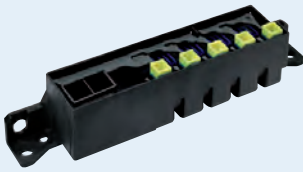

Outlets: 5
Supply Voltage (VAC) 120 - 240; 220 - 240
Tabs: LV 6,3x0,8 - HV 2,8x0,8

1000 series - snap

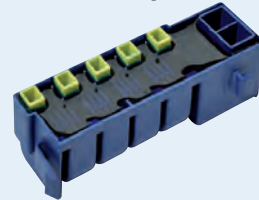

Outlets: 5
Supply Voltage (VAC) 220 - 240
Tabs: LV 6,3x0,8 - HV 2,8x0,8

800 series - screw



Outlets: 2 - 4 - 6
Supply Voltage (VAC) 120 - 240; 220 - 240
EMC Filter: on demand
Tabs: LV 6,3x0,8 - HV 2,8x0,8

800 series - snap



Outlets: 2 - 4 - 6
Supply Voltage (VAC) 120 - 240; 220 - 240
EMC Filter: on demand
Tabs: LV 6,3x0,8 - HV 2,8x0,8

2200 series integrated switch



Outlets: 2 - 4
Supply Voltage (VAC) 220 - 240
Tabs: LV 6,3x0,8 - HV 2,8x0,8

250 series integrated switch



Outlets: 2 - 4
Supply Voltage (VAC) 120; 220 - 240
S.Voltage (Vdc): 1,5; 9; 12
EMC Filter: on demand
Tabs: LV 6,3x0,8 - HV 2,8x0,8

500 series - screw



Outlets: 2 - 4 - 6 - 8
Supply Voltage (VAC) 120 - 240; 220 - 240
S.Voltage (Vdc): 1,5; 9; 12
EMC Filter: on demand
Tabs: LV 6,3x0,8 - HV 2,8x0,8

Gas igniters with integrated terminal block

900 series

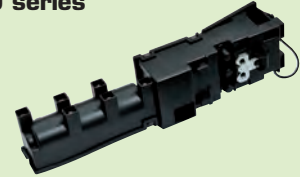

Outlets: 2 - 4 - 6
Supply Voltage (VAC) 120; 220 - 240
EMC Filter: on demand
Tabs: screw connection
 HV 2,8x0,8

Customized Solution



Design: on demand

For any requests and on clarifications about products here showed, please address your enquiries to info@twispracontrols.com or call +39 0382 789311

Legenda

LV: Low Voltage
 HV: High Voltage

Re-igniters

800 series

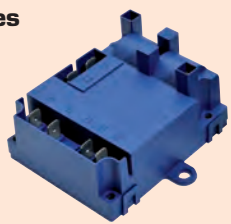

Outlets: 1 - 2
Supply Voltage (VAC) 220 - 240
Optional: 800 series transformer
Tabs: LV 6,3x0,8 - HV 2,8x0,8



800 series

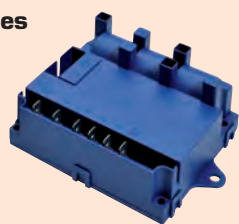

Outlets: 3
Supply Voltage (VAC) 220 - 240
Optional: 800 series transformer
Tabs: LV 6,3x0,8 - HV 2,8x0,8



800 series transformer



Outlets: 4 - 6
Tabs: LV 6,3x0,8 - HV 2,8x0,8



650 series

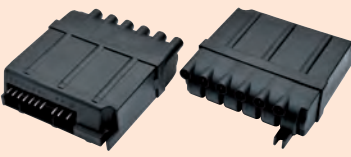

Outlets: 4 - 5 - 6
Supply Voltage (VAC) 120; 220 - 240
Tabs: LV 11 way connector
 HV 2,8x0,8



140 series - screw/snap



Outlets: 1
Supply Voltage (VAC) 120
Tabs: LV 6,3x0,8 - HV 2,8x0,8





Switch harnesses

930 series - push





Layout: on demand
Supply Voltage (VAC) 250
Current Rating: 0,1 A
Suitable for a wide range of gas taps

925 series - push

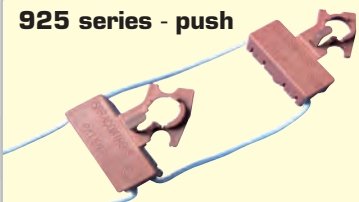

Layout: on demand
Supply Voltage (VAC) 250
Current Rating: 0,1 A
Suitable for BSI gas taps

915 series - push



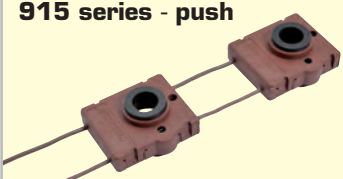

Layout: on demand
Supply Voltage (VAC) 250
Current Rating: 0,1 A
Suitable for SABAF gas taps



905 series - push/rotative



Layout: on demand
Supply Voltage (VAC) 250
Current Rating: 0,1 A
Suitable for a wide range of gas taps

905 series - control on single tap

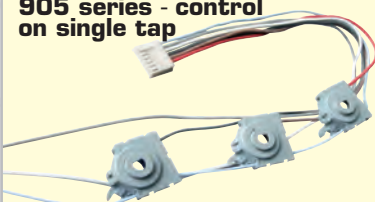

Layout: on demand
Supply Voltage (VAC) 250
Current Rating: 0,1 A
Suitable for a wide range of gas taps



Led display

Multiple modules

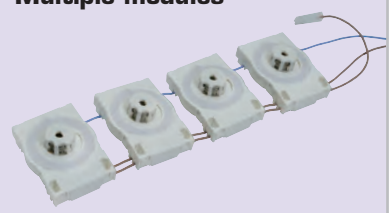

with integrated switch for ignition
Design: on demand

Single module



Design: on demand

Oven cavity lighting

Strip led



Design: on demand

Legenda

LV: Low Voltage
 HV: High Voltage

For any requests and/or clarifications about products here showed, please address your enquiries to info@itwispracontrols.com or call +39 0332 733311

Electronic controls

Oven core board

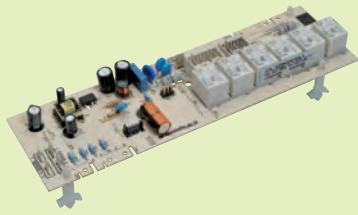

Design: on demand

Oven user interface

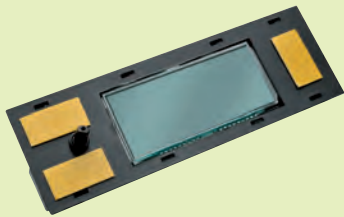

Design: on demand

Oven control with touch user interface

Timer - Oven temperature control

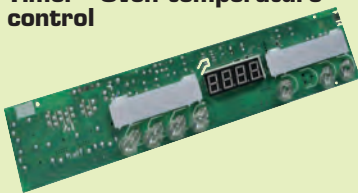

Design: on demand

Selectors

Resistive selector for oven



Position #: on demand

Igniters

120 series

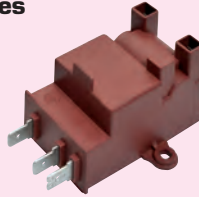

Outlets: 2
 S.Voltage (Vac): 220 - 240
 EMC Filter: on demand
 Tabs: LV 6,3x0,8 - HV 2,8x0,5/0,8

121 series

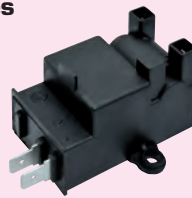

Outlets: 2
 Supply Voltage (VAC) 220 - 240
 EMC Filter: on demand
 Tabs: LV 6,3x0,8 - HV 2,8x0,8

150 series



Outlets: 2
 Supply Voltage (VAC) 120; 220-240
 Inno Outlet: 1
 EMC Filter: on demand
 Tabs: Inno 4,8x0,8 - LV 6,3x0,8
 HV 2,8x0,8

880 series



Outlets: 2
 Supply Voltage (VAC) 220 - 240
 Power supply cable: Customized
 EMC Filter: on demand
 Tabs: HV 2,8x0,8
 Fits on solenoid valves

885 series



Outlets: 2
 Supply Voltage (VAC) 220 - 240
 Power supply cable: Customized
 EMC Filter: on demand
 Tabs: HV 2,8x0,8
 Fits on solenoid valves

890 series



Outlets: 2
 Supply Voltage (VAC) 220 - 240
 Power supply cable: customized
 EMC Filter: on demand
 Tabs: HV 2,8x0,8
 Fits on solenoid valves

140 series



Outlets: 1
 Supply Voltage (VAC) 220 - 240
 EMC Filter: on demand
 Tabs: LV 6,3x0,8 - HV 2,8x0,8

Motor Fan Control

3 - phase BLDC sensorless motor control



Design: on demand

Legenda

LV: Low Voltage
 HV: High Voltage